

## Pattern C-Turnier Wiedergeltingen

04./05.06.2016

<u>Prüfung</u>	<u>Pattern</u>
Reining LK 3B	#2
Reining LK 4	#12
Reining LK 3A	#2
Reining LK 1/2 A/B	#4
Superhorse LK 1/2	#2
Western Riding LK 3	#6
Western Riding LK 1/2 A	#2



# 2015 Ranch Riding Pattern 13 (Arenagröße mind. 20x40): LK 1-3 A/B

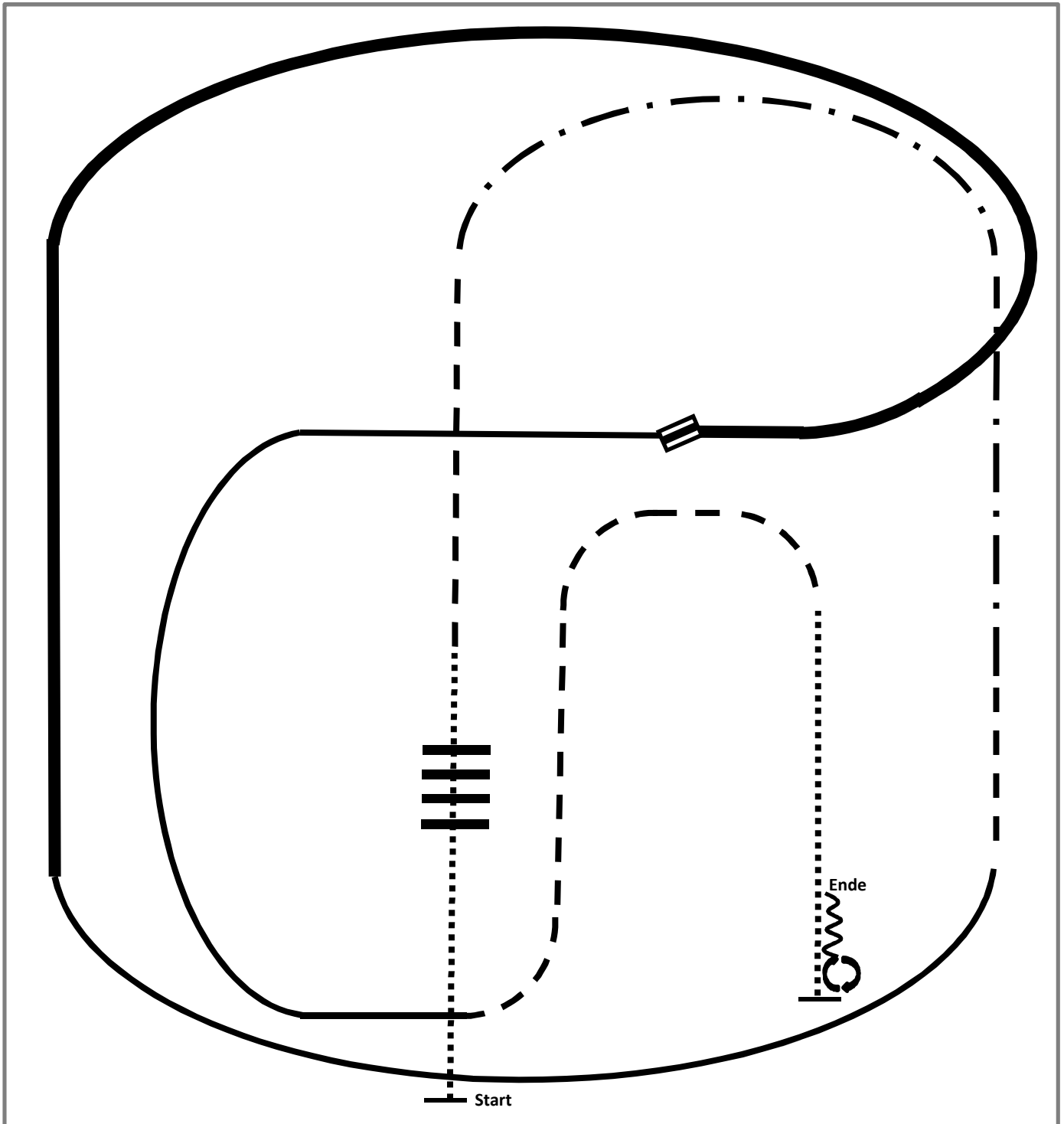

- 1.Walk over
- 2.Trot
- 3.Ext.Trot, Trot
- 4.Lope right lead
- 5.Ext. Lope right lead
- 6.Change leads
- 7.Lope left lead

- 8.Trot
- 9.Walk
- 10.Stop, Turn 360° each direction  
(either way first)
- 11.Back

	Back
	Lope
	Ext. Lope
	Trot
	Ext. Trot
	Walk
	Lead change flying/simple



# 2015 Ranch Riding Pattern 14 (Arenagröße mind. 20x40): LK 4/5 A/B

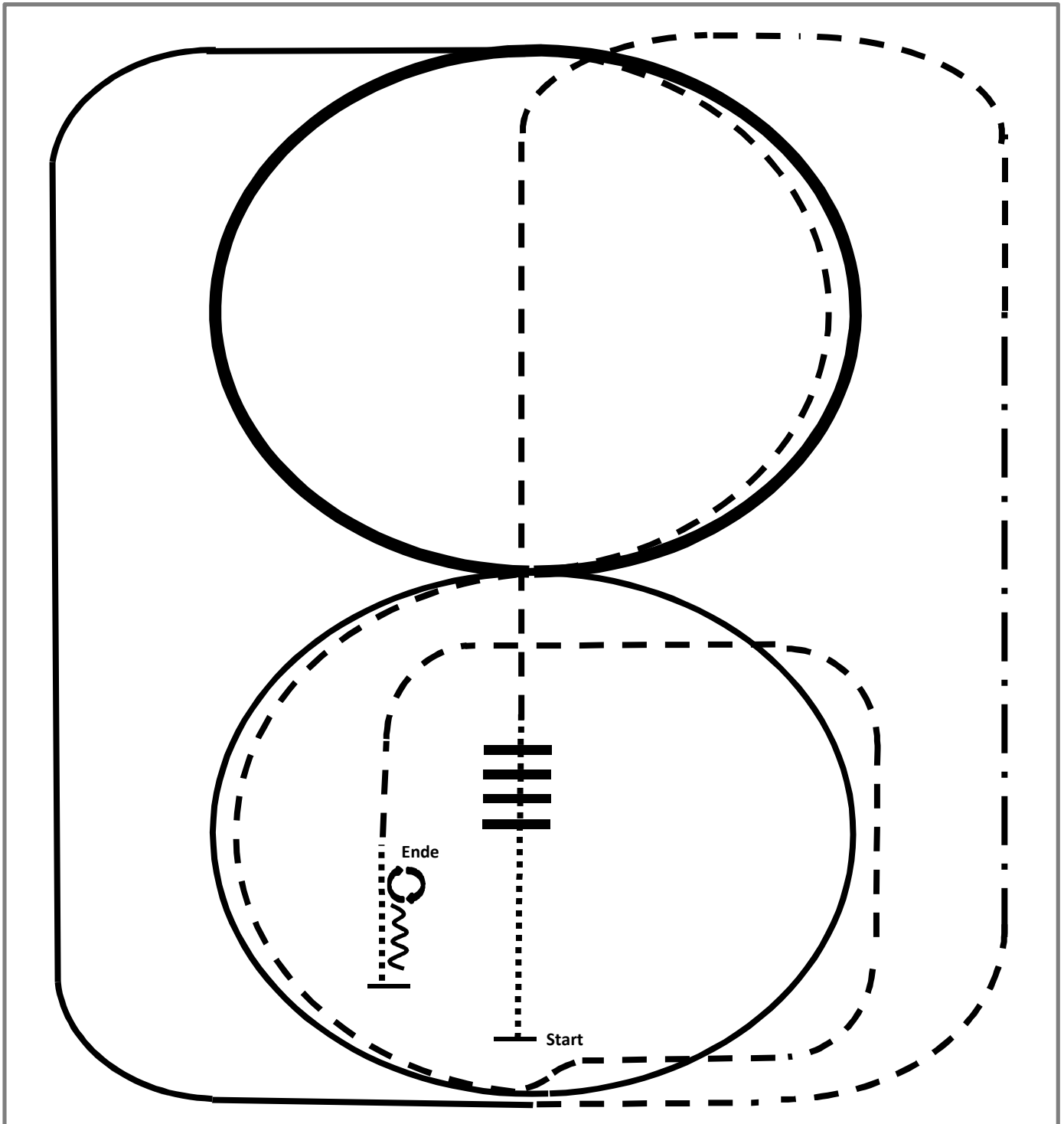

- 1.Walk
- 2.Walk over
- 3.Trot
- 4.Ext. Trot, Trot
- 5.Lope right lead
- 6.Ext. Lope circle right lead
- 7.Trot (2x ½ circle)

- 8.Lope left lead circle
- 9.Trot
- 10.Walk
- 11.Stop, Back
- 12.Turn right 180°
- 13.Turn left 180°

	Back
	Lope/Galopp
	Ext. Lope
	Trot/Trab
	Ext. Trot
	Walk/Schritt
	Lead change flying/simple



## Showmanship at Halter LK 1/2 A/B

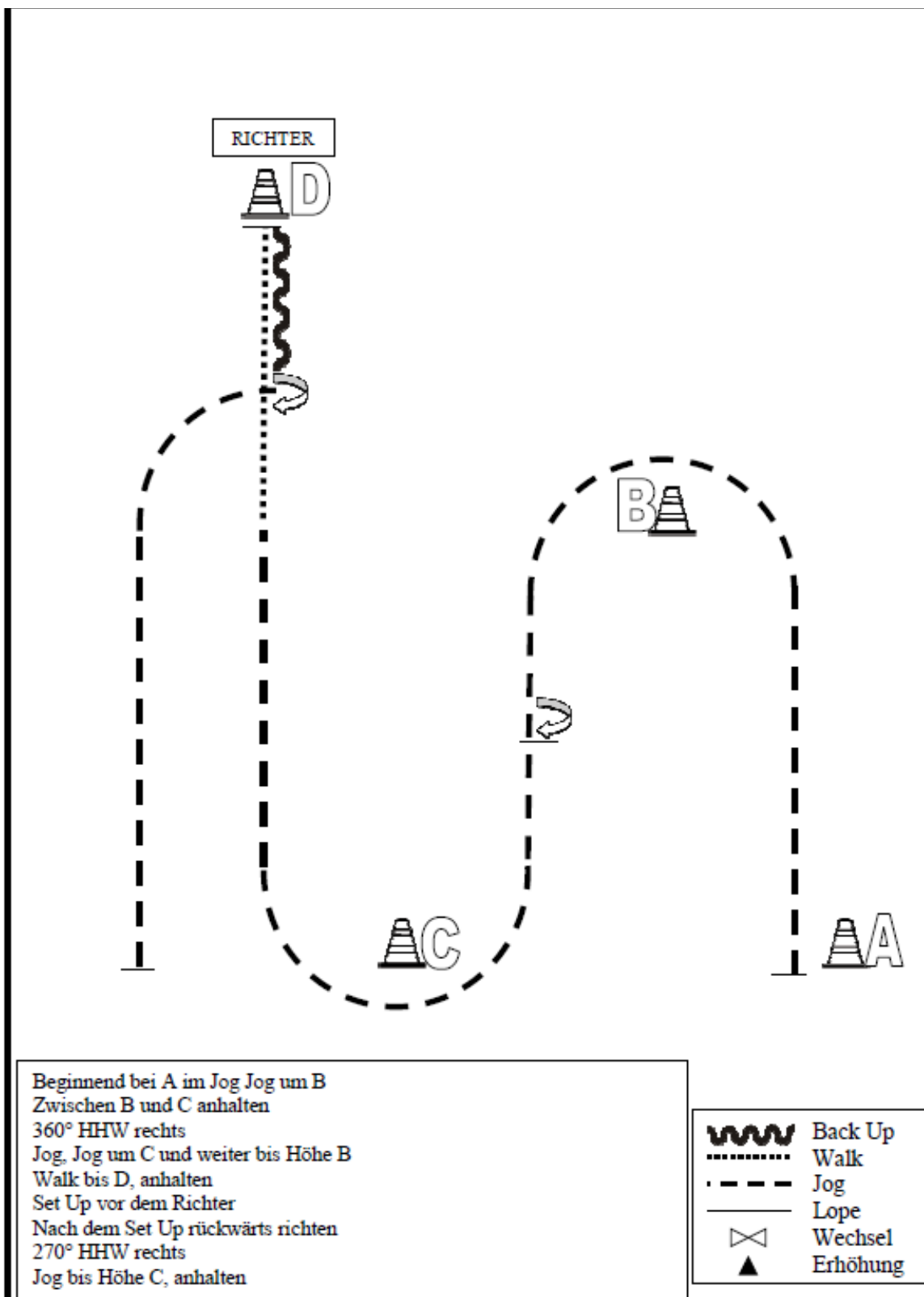





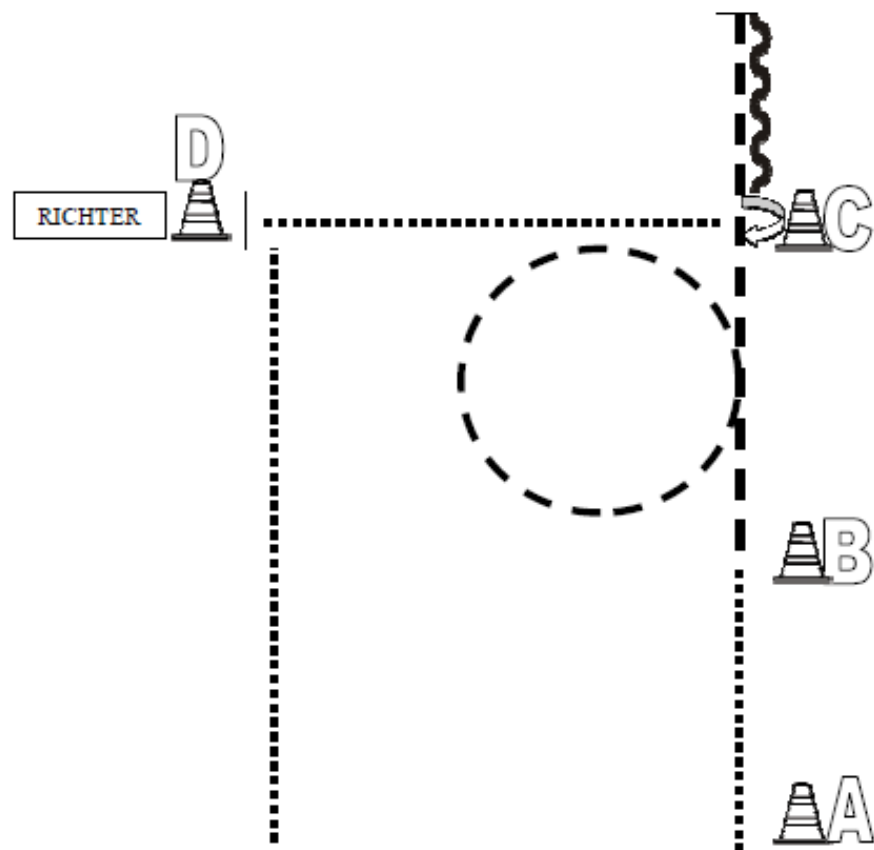

# Showmanship at Halter

LK 5/4 A/B

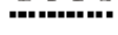

Von A nach B Walk  
 Bei B Jog, zwischen B und C Jog-Volte links  
 Hinter C anhalten, Rückwärtsrichten  
 270° HHW rechts  
 Walk bis D, anhalten  
 Set Up vor dem Richter  
 Nach dem Set Up Walk

	Back Up
	Walk
	Jog
	Lope
	Wechsel
	Erhöhung

C

H

E

K

M

B

F

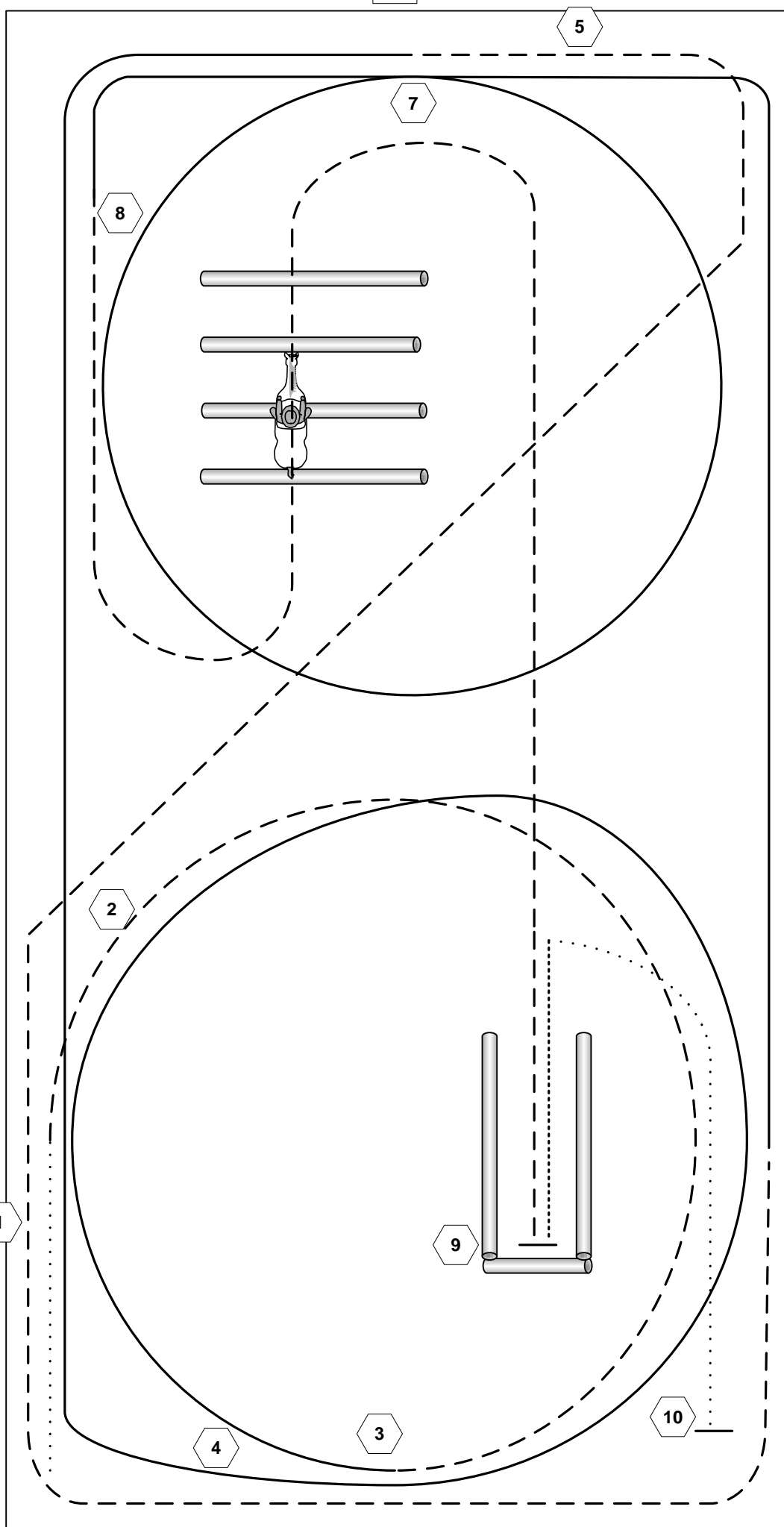

1. Im Schritt bis K, dort antraben
2. auf dem Zirkel geritten
3. bei A einen Zirkel Rechtsgalopp
4. ganze Bahn Rechtsgalopp bis C
5. Jog – durch die ganze Bahn wechseln – Jog bis F
6. bei F Linksgalopp bis C
7. einen Zirkel Linksgalopp – weiter ganze Bahn bis H
8. Jog – Jog over
9. Jog in - Backup
10. Halten u. verharren

Walk  
 .....  
 Jog  
 - - - - -  
 Lope  
 \_\_\_\_\_  
 Back  
 - - - - -





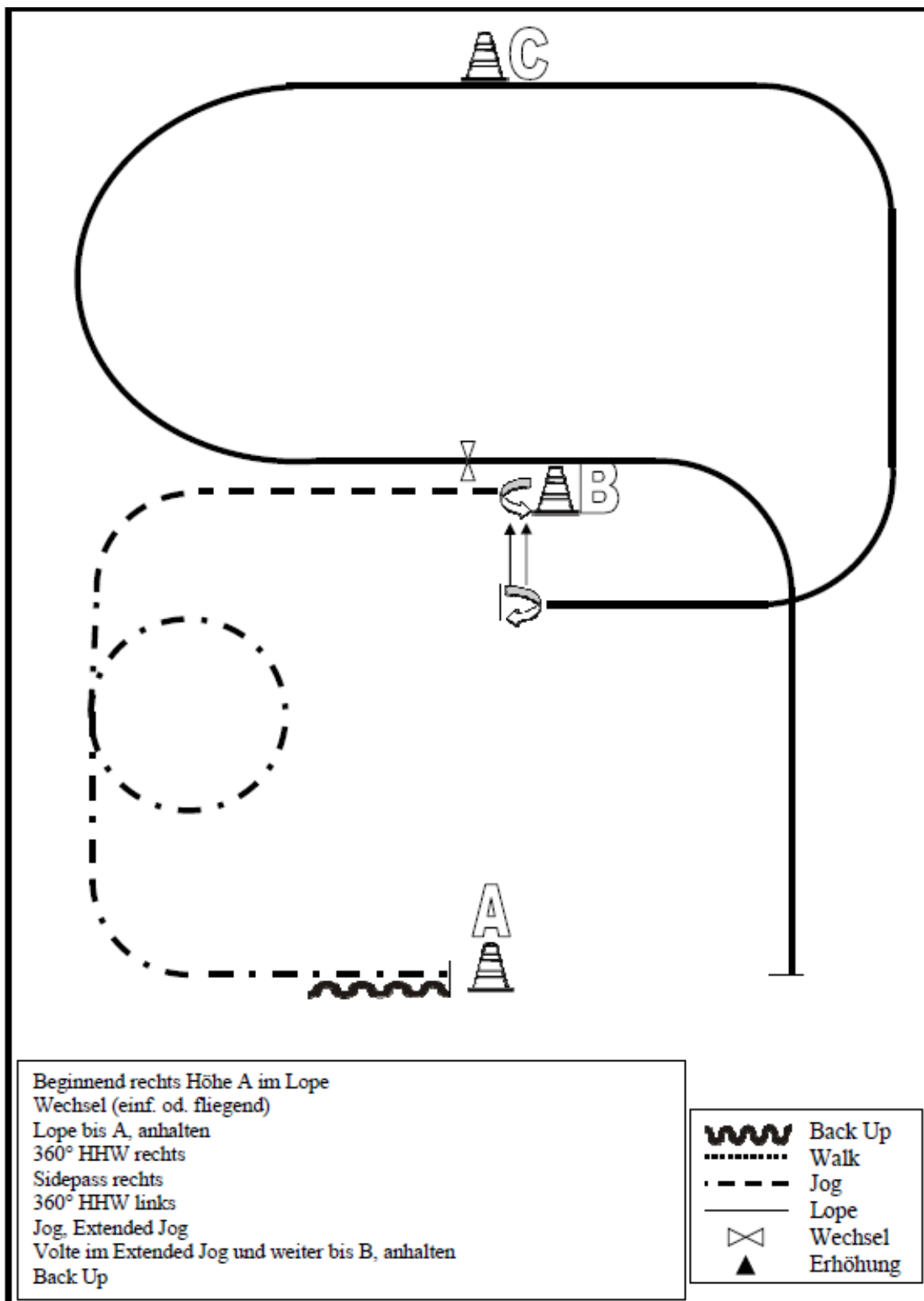

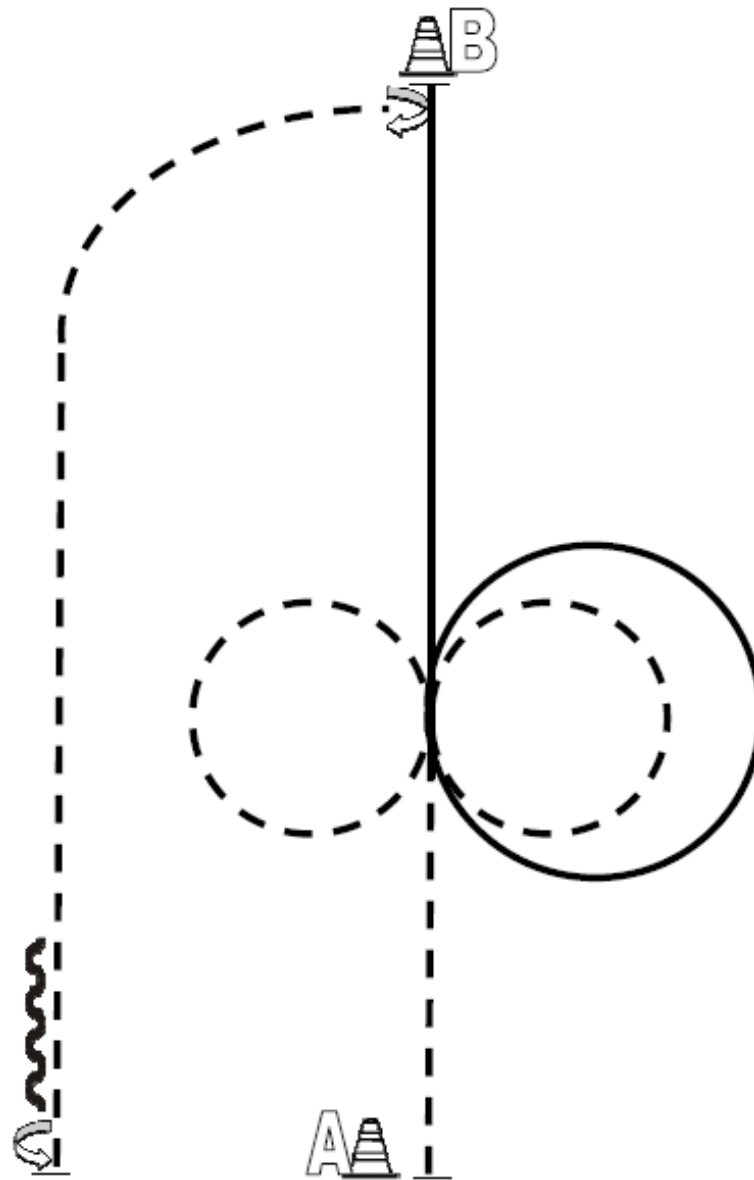
## Western Horsemanship LK 1/2 A/B



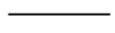

Beginnend bei A im Jog  
 Jog Mitte der Bahn  
 Jog-Volte rechts, Jog-Volte links,  
 Lope rechts, Lope-Volte rechts  
 Lope bis B, anhalten  
 270° HHW rechts  
 Jog bis Höhe A, anhalten  
 360° HHW links  
 Back Up

	Back Up
	Walk
	Jog
	Lope
	Wechsel
	Erhöhung

# Western Horsemanship LK 4A

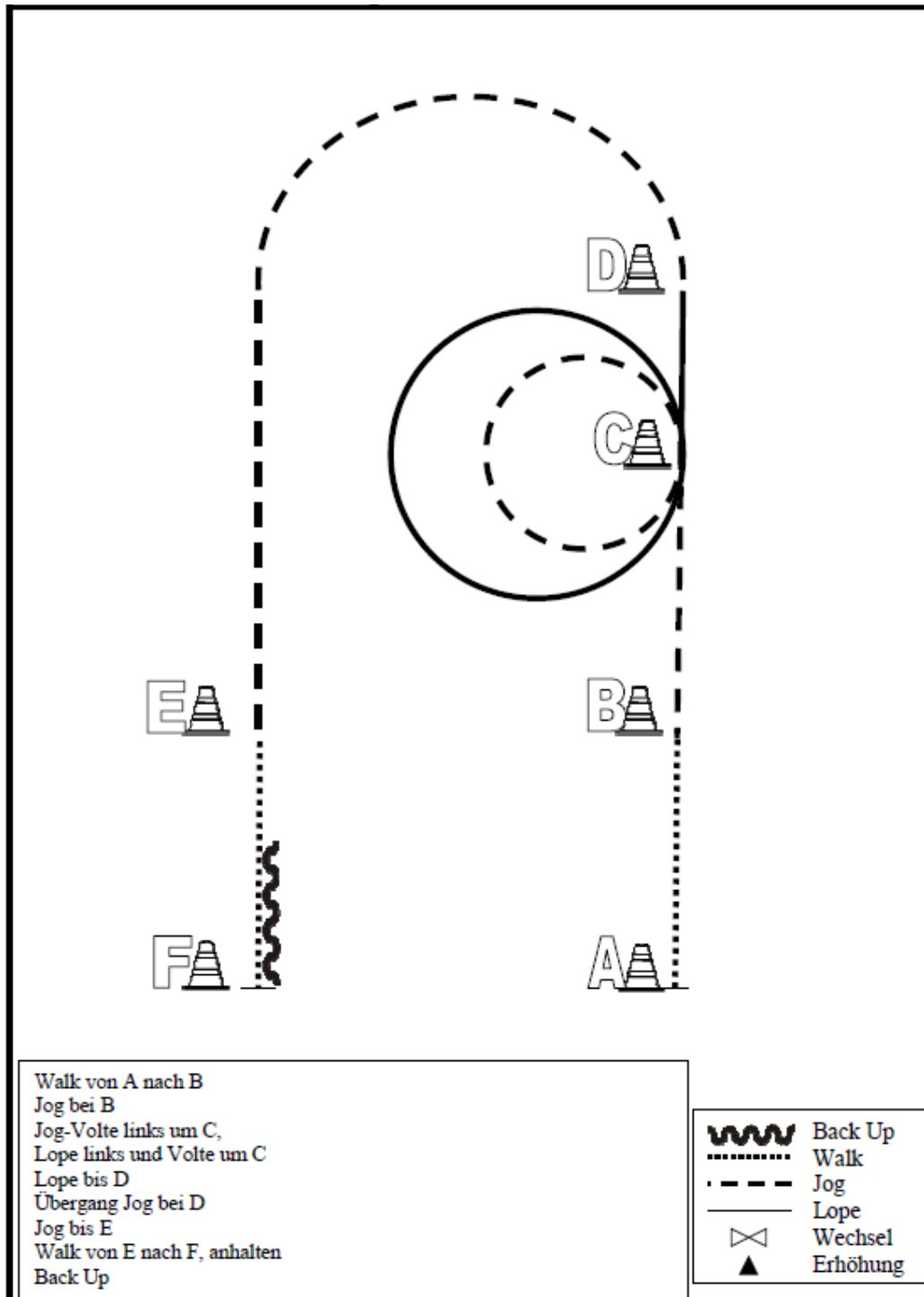

## Western Horsemanship LK 4/5 B // LK 5A

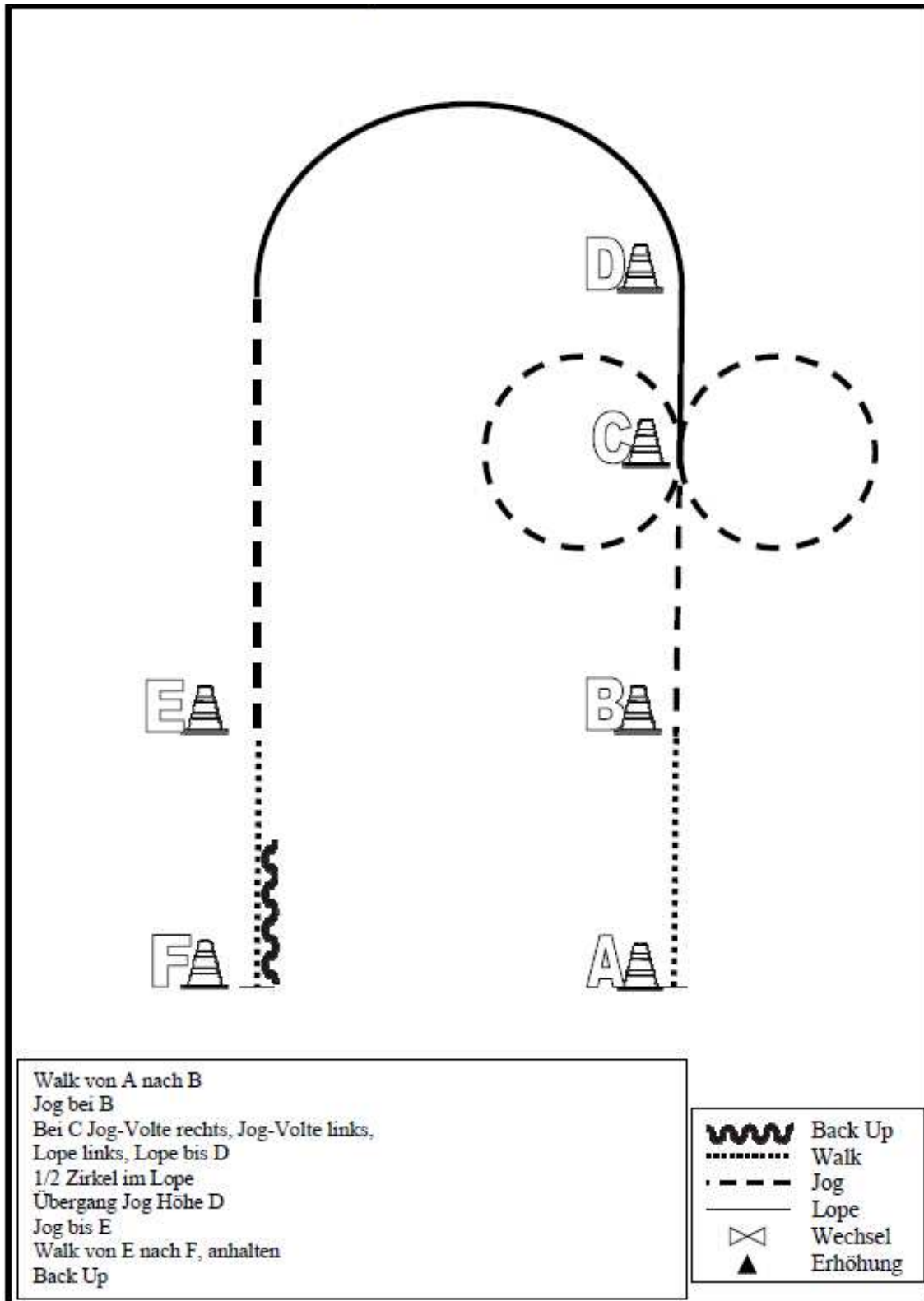

## Sonderprüfung WHS LK 4-5 A/B

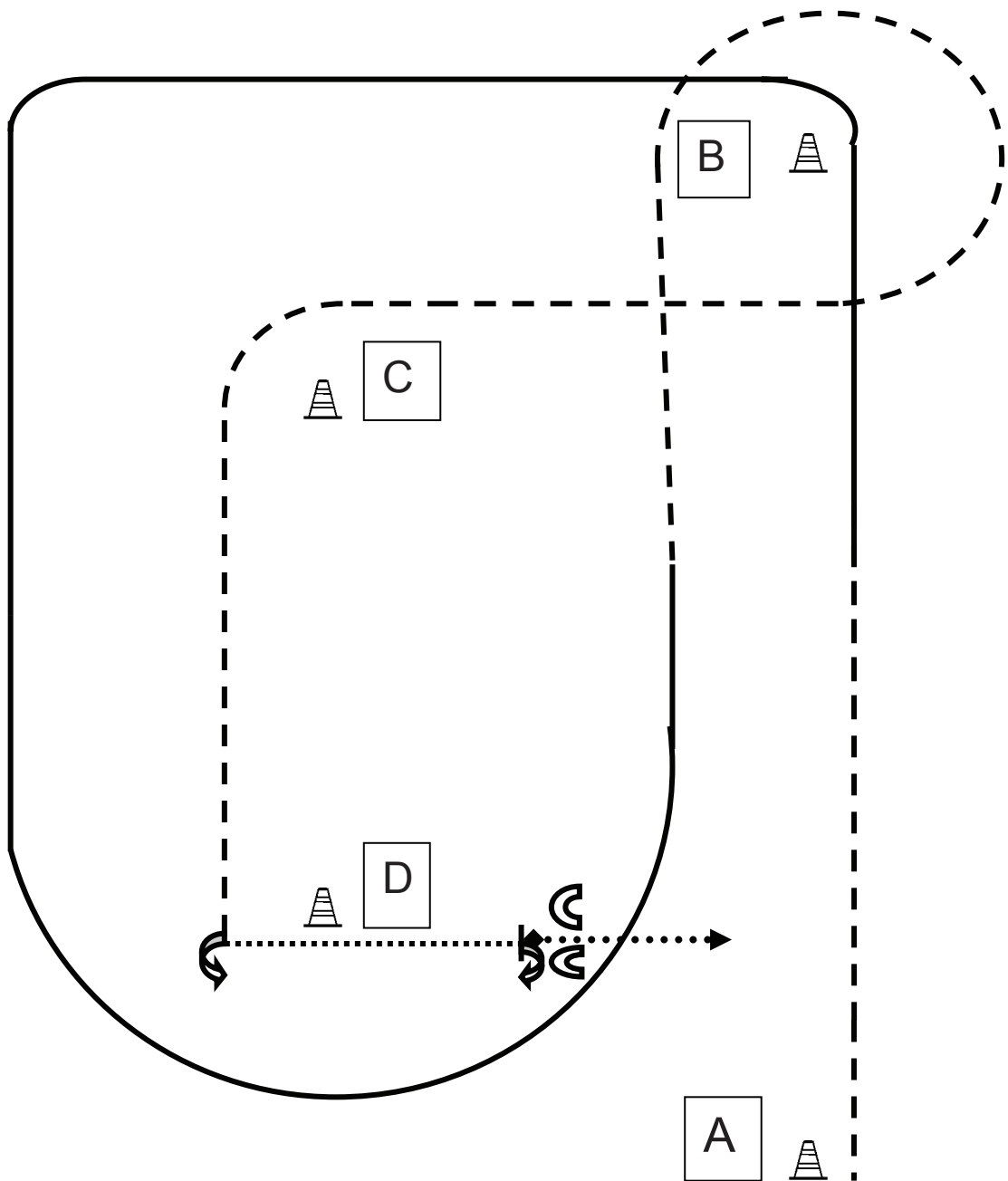

1. Jog bei A – Übergang zum Linksgalopp,
2. Übergang zum Jog – Bogen um B – halber Bogen um C
3. Höhe D Stop –  $1 \frac{1}{4}$  HHW links weiter im Schritt – Stop 180° HHW rechts – eine Pferdelänge back

# Sonderprüfung WHS LK 1-3 A/B

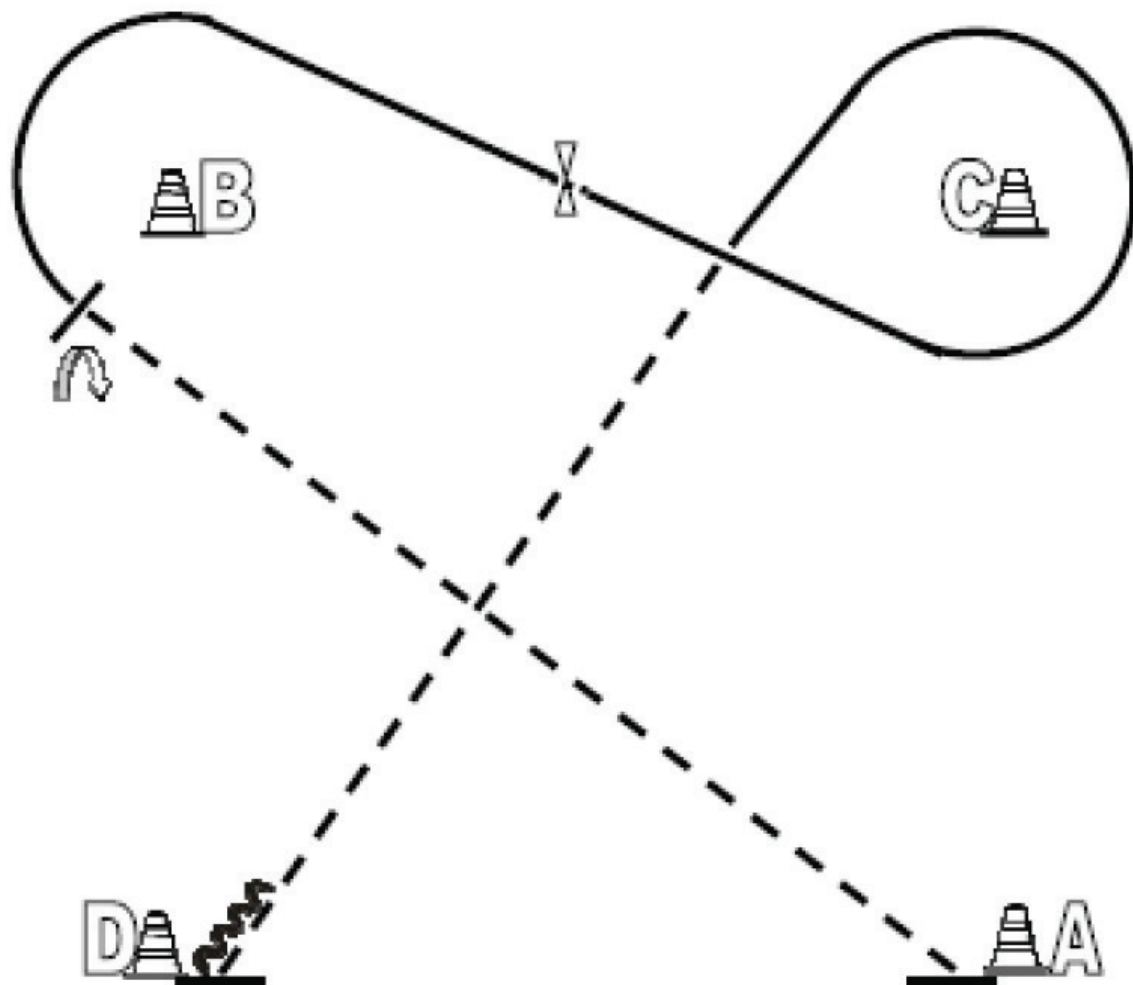



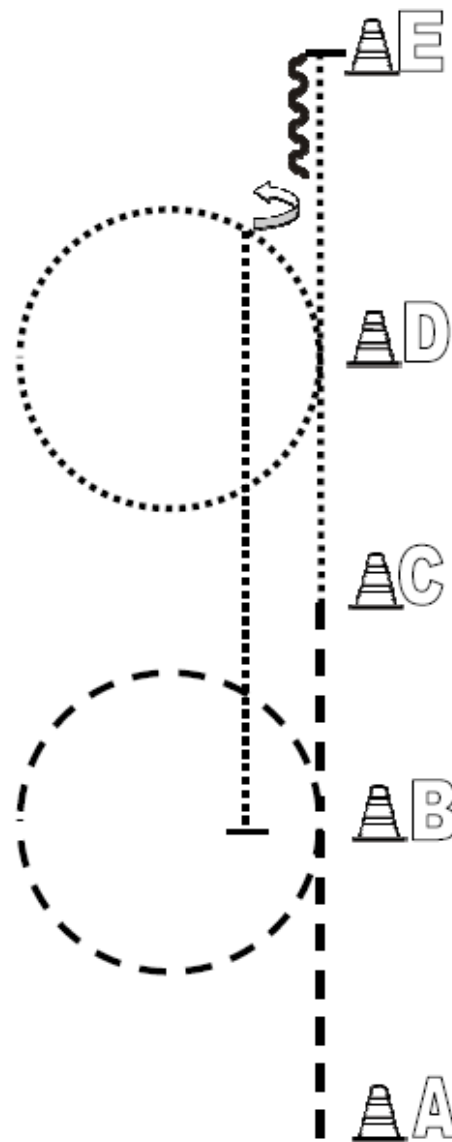

1. Von A nach B Jog  
Bei B anhalten  
360° HHW rechts
2. Lope right um B  
Einfacher Wechsel über Walk  
Lope left um C
3. Höhe C Jog und weiter bis D  
Bei D anhalten  
Rückwärtsrichten  
Im Jog zurück zum WarmUp-Bereich

	Back Up
	Walk
	Jog
	Lope
	Wechsel

# Walk Trot Western Horsemanship



Von A nach B Jog  
 Bei B Jogvolte links  
 Von B bis C Jog  
 Von C bis D Walk  
 Bei D Walkvolte links  
 Walk bis E, Stop und mind. 3 m rückwärtsrichten  
 ½ HHW links  
 Walk bis B, Stop  
 Im Walk zurück ins Line Up

	Back Up
	Walk
	Jog
	Lope
	Wechsel

# Trail LK 1/2 A/B

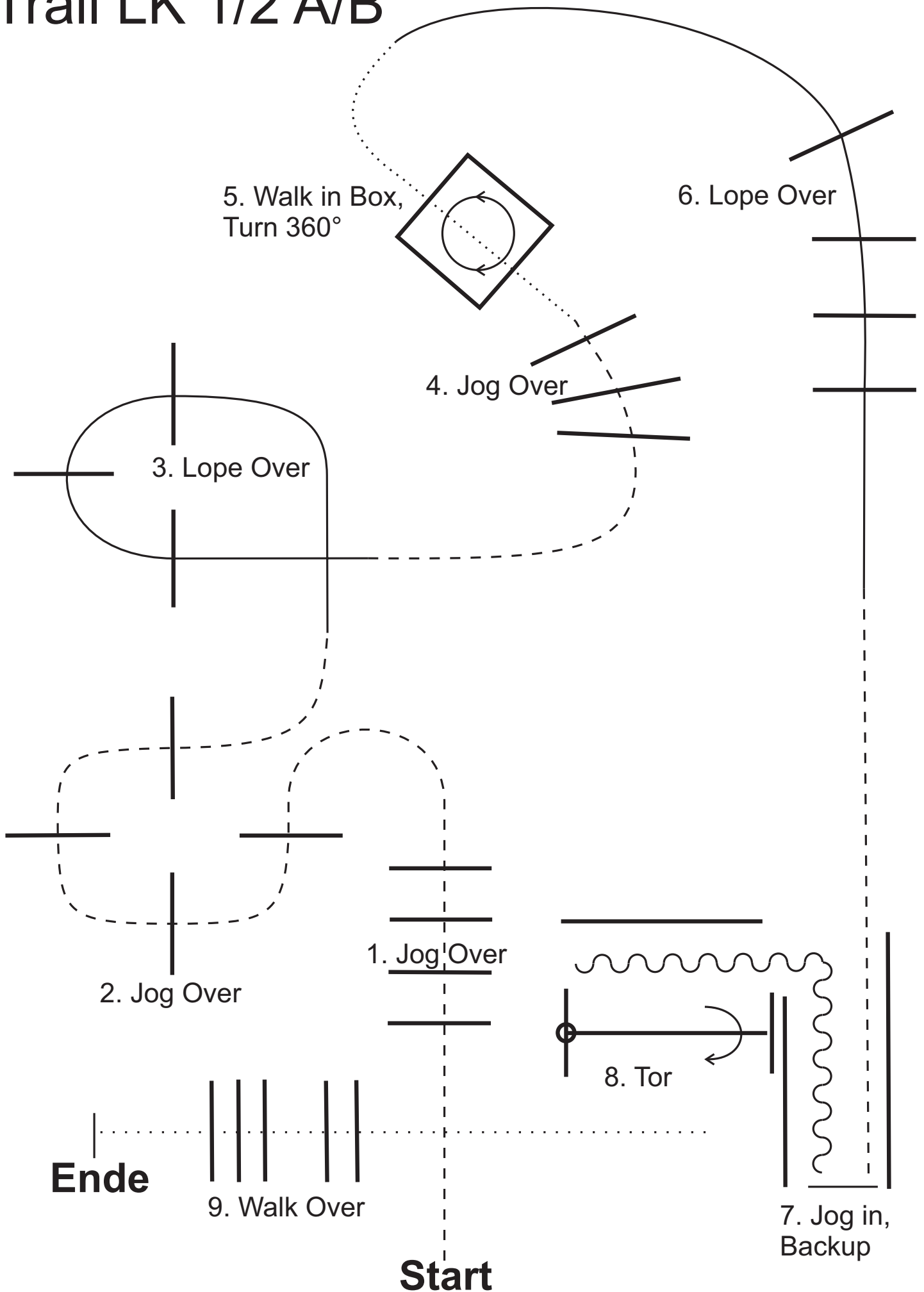



# SO Meisterschaft Trail LK 1/2 A/B

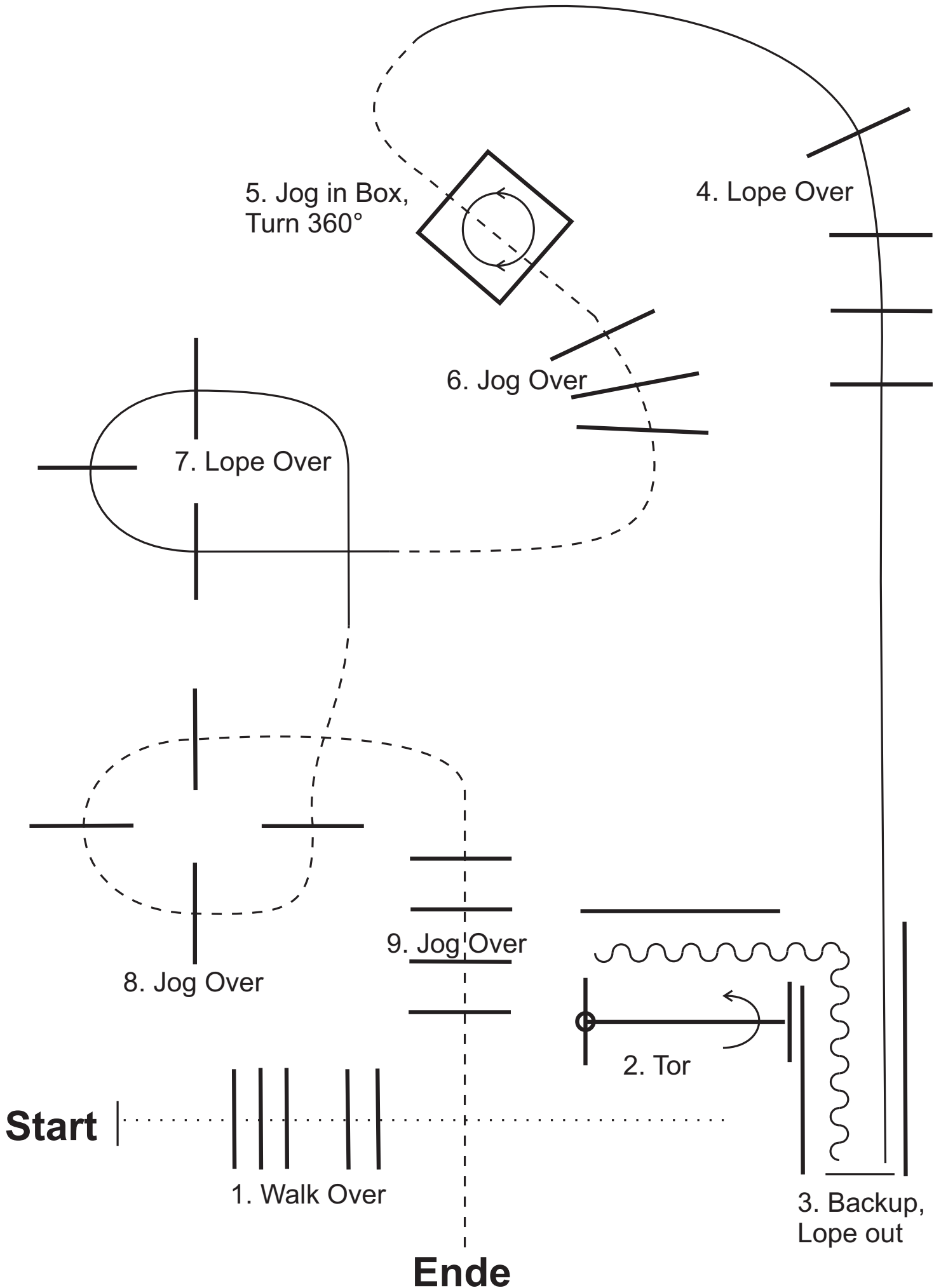

# Trail LK 3 A/B

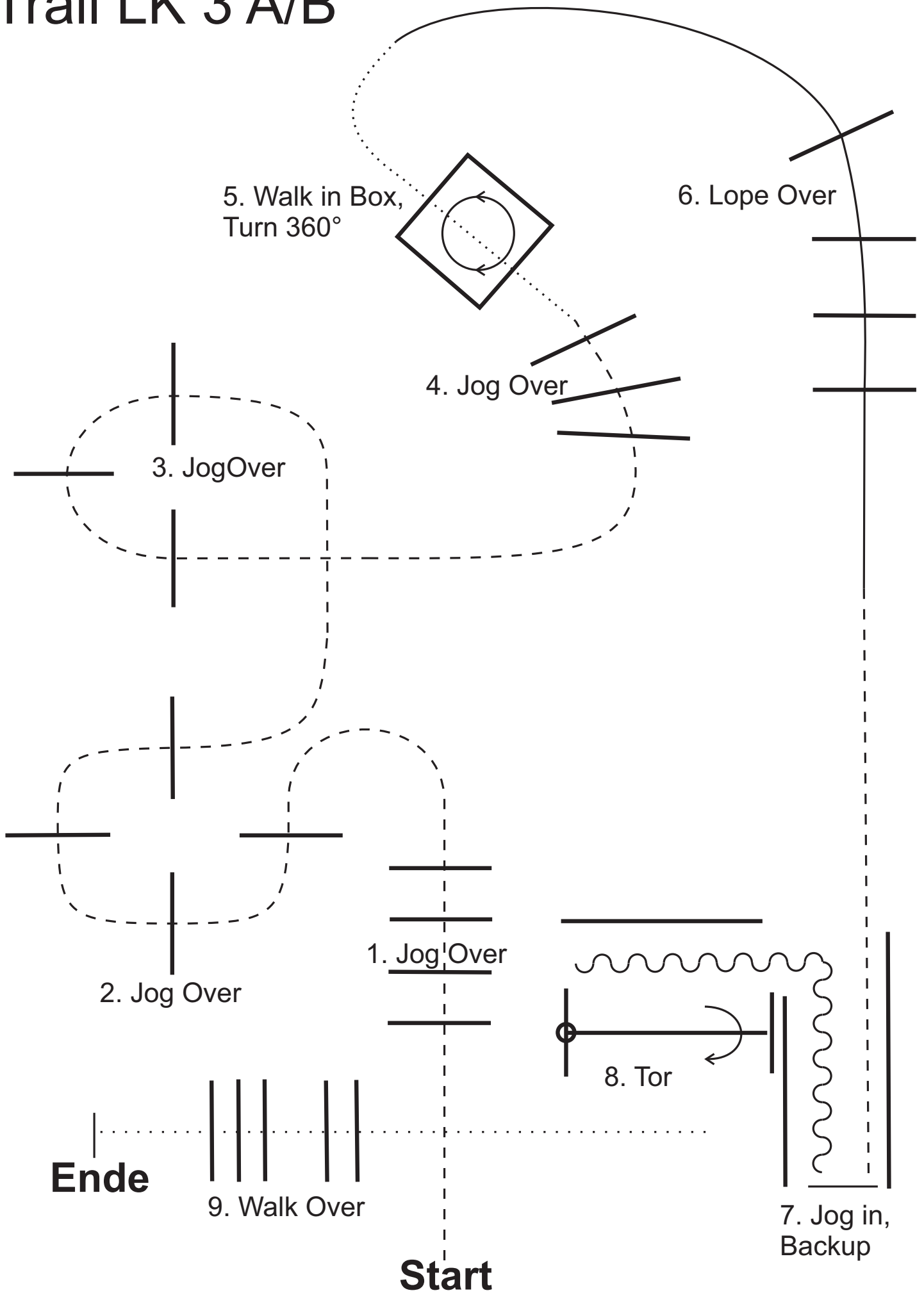

# Trail LK 4/5 A/B

## SO4 Trail für 4-6 j. Pferde

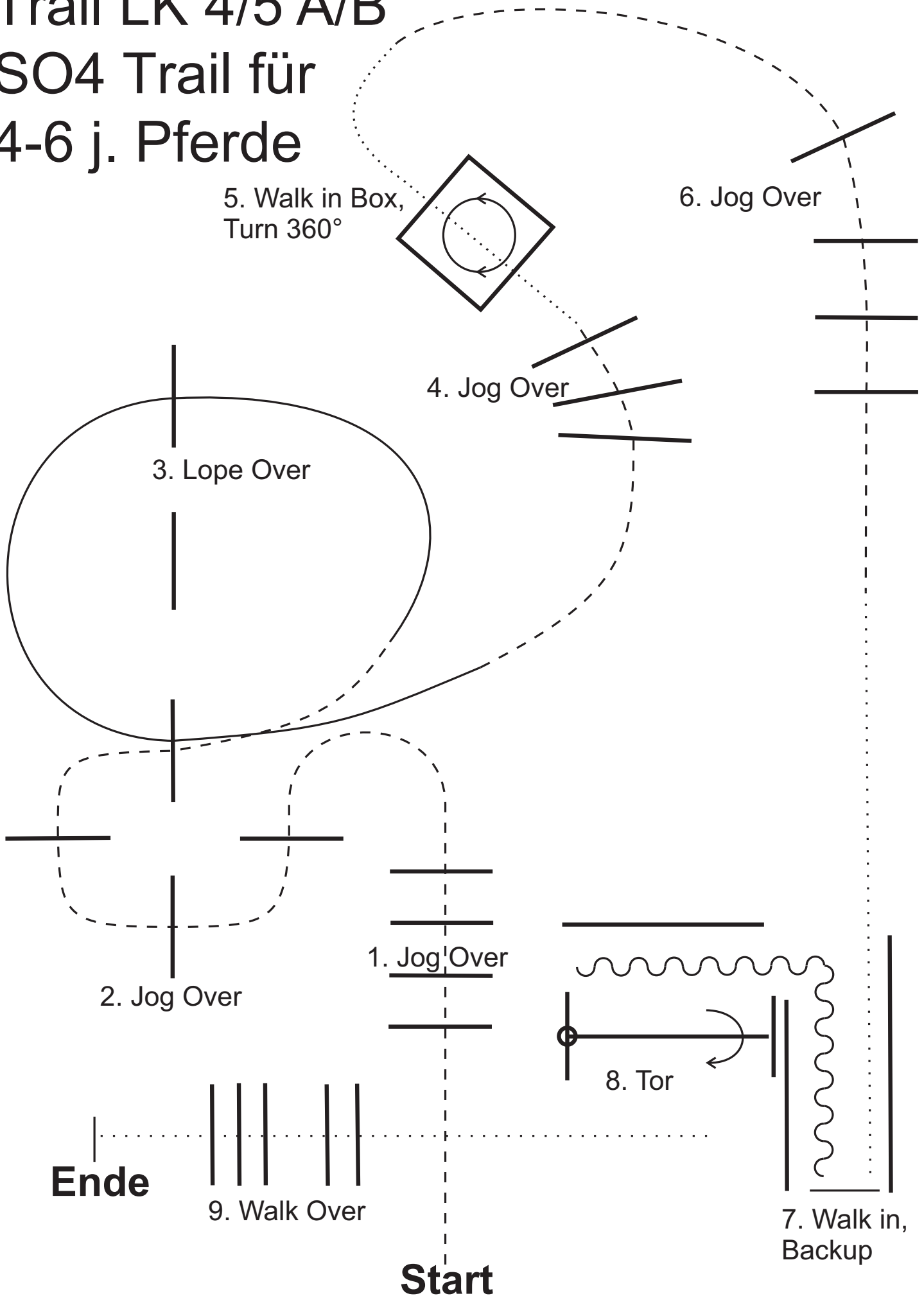

# Walk Trot Trail

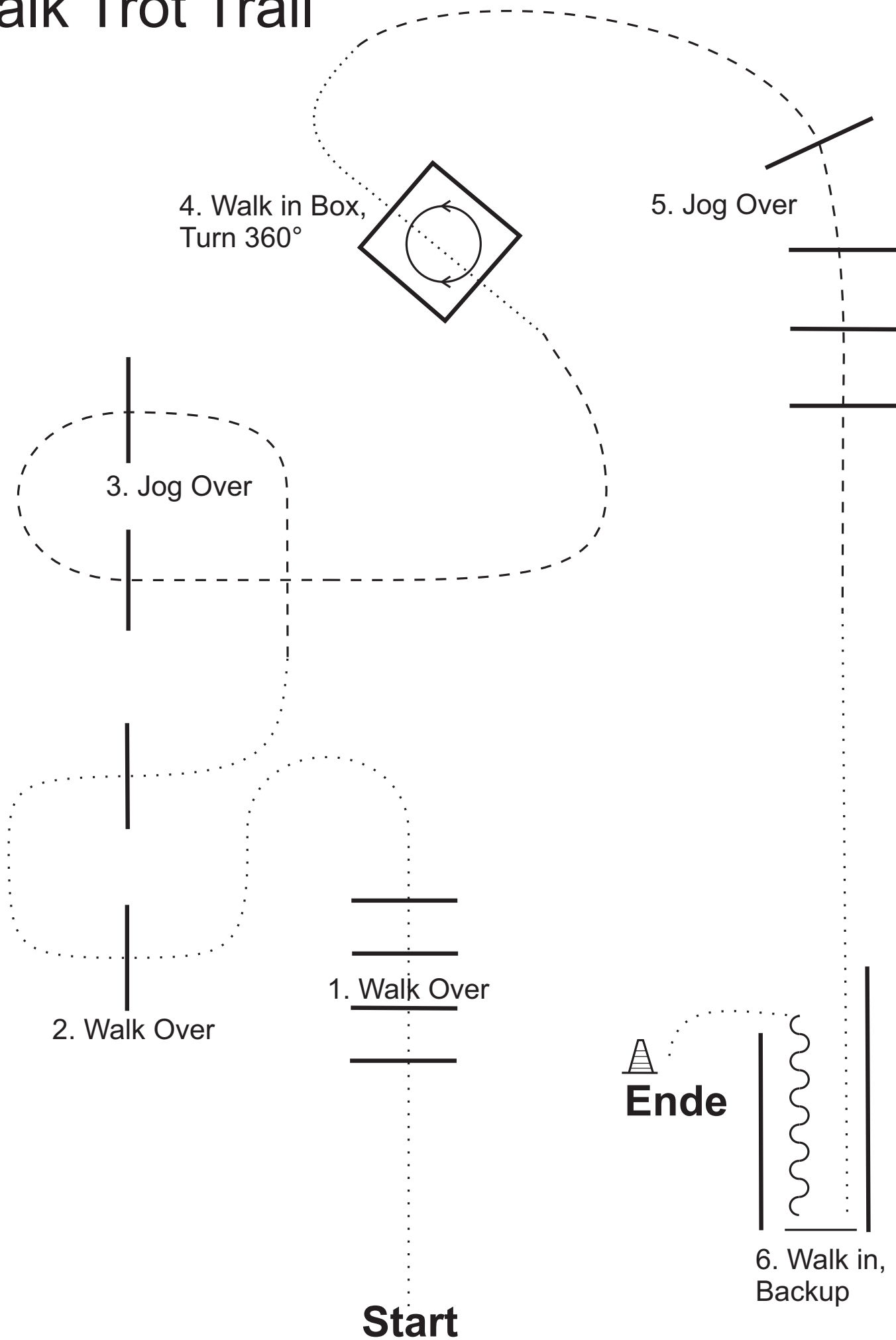

# Freestyle Trail

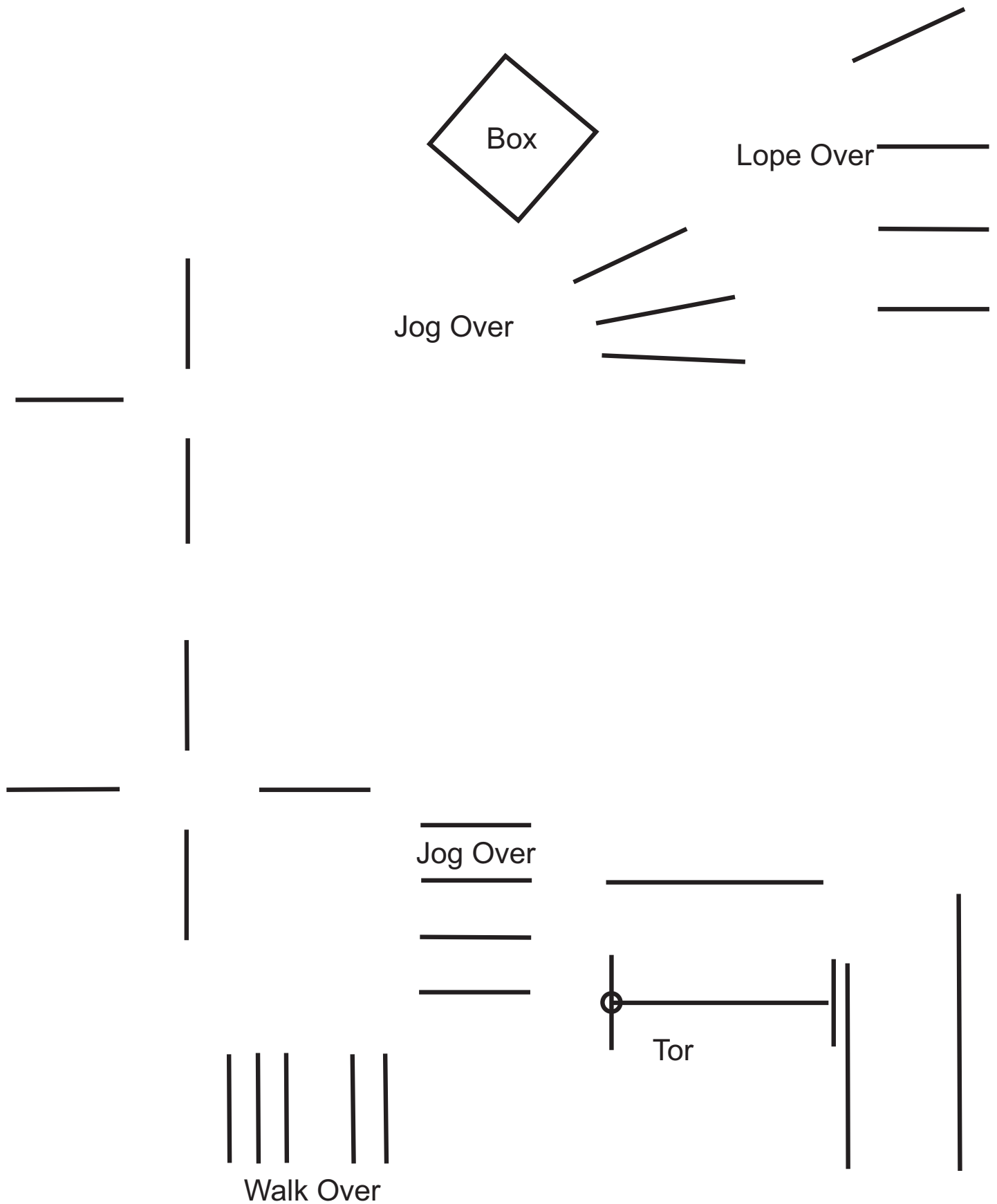

## Pflichthindernisse:

- Tor
- Überreiten von min. 4 Stangen
- BackUp zwischen Stangen oder Pylonen

**Freestyle Trail:** Beim Freestyle Trail werden einige Elemente des Trails in der Bahn ausgebaut (einen Aufbauplan bekommen alle Starter dieser Disziplin nach Nennschluss zugeschickt). Aus diesen Elementen kann jeder Starter auswählen was er nutzen will und wie seine Pattern aussehen soll (die Pflichtelemente sind zu beachten). Es darf gerne in Verkleidung und zu einer gewünschten Musik geritten werden, außerdem darf ohne Sattel u/o ohne Trense geritten werden. Alle Ausrüstungsgegenstände müssen jedoch dem EWU Regelwerk entsprechen. Die Pattern ist bis spätestens eine Stunde vor Prüfungsbeginn in der Meldestelle abzugeben.

# Führzügelklasse

