

Start	Klasse
	<b>Samstag, 27.04.2013</b>
08:00	103200 Open - Two Yr Old Stallions (1) 203100 Amt Yearling Stallions (1) 203200 Amt Two Yr Old Stallions (1) 107700 Open - Aged Geldings (2)
08:15	207702 Amt Aged Geldings - Novice (3) 277000 Amt Performance Halter Geldings (1) 407702 Youth Aged Geldings - Novice (2)
08:30	105400 Open - Yearling Mares (1) 105600 Open - Three Yr Old Mares (1) 105700 Open - Aged Mares (4) 175000 Open - Performance Halter Mares (1) Open Grand Champion Mares 205400 Amt Yearling Mares (2) 205402 Amt Yearling Mares - Novice (2) 205600 Amt Three Yr Old Mares (1) 205602 Amt Three Yr Old Mares - Novice (1) 205702 Amt Aged Mares - Novice (2) 405702 Youth Aged Mares - Novice (2)
09:30	EWU: LK 4/5 A/B, Showmanship at Halter (9)
09:45	212001 Amt Showmanship at Halter - Rookie (2) 212002 Amt Showmanship at Halter - Novice (5) 212000 Amt Showmanship at Halter (2) 412002 Youth Showmanship at Halter - Novice (4)
10:27	EWU: LK 5 A/B, Western Pleasure (6)
11:00	EWU: LK 4 B, Trail (5)
11:30	138004 Open - Trail - Green (10)
12:15	438002 Youth Trail - Novice (6)
12:45	EWU: LK 5 A/B, Trail (9)
13:30	EWU: LK 4 A, Trail (14)
14:30	138000 Open - Trail (7)
15:10	EWU: LK 5 A/B, Western Horsemanship (5)
15:29	EWU: LK 4 B, Western Pleasure (6)
15:46	EWU: LK 4 A, Western Pleasure (15)
16:30	234001 Amt Reining - Rookie (3)
16:47	234002 Amt Reining - Novice (7)
17:30	234000 Amt Reining (6)
18:00	440002 Youth Western Horsemanship - Novice (3)
18:16	EWU: LK 4 B, Western Horsemanship (6)
18:36	EWU: LK 4 A, Western Horsemanship (13)
19:15	134004 Open - Reining - Green (4)
19:36	134000 Open - Reining (6)
20:15	EWU: LK 4 A, Reining (9)

ACHTUNG: Die AQHA-Klassen können, wenn der Zeitplan es zulässt, auch bis zu 15 Minuten vor der angegebenen Startzeiten beginnen. Bitte unbedingt auf die Ansagen während des Tages achten. Die Teilnehmer sind selbst für das rechtzeitige Erscheinen zu den Prüfungen verantwortlich!

Start	Klasse
	<b>Sonntag, 28.04.2013</b>
08:00	444002 Youth Hunter Under Saddle - Novice (3)
08:15	EWU: LK 3 A/B Showmanship at Halter (2)
08:30	136004 Open - Western Riding - Green (2)
08:41	436002 Youth Western Riding - Novice (2)
08:52	136000 Open - Western Riding (2)
09:03	EWU: LK 3 Western Riding (1)
09:10	442002 Youth Western Pleasure - Novice (5)
09:30	242001 Amt Western Pleasure - Rookie (3)
09:45	242002 Amt Western Pleasure - Novice (8)
10:05	EWU: LK 3, Western Pleasure (8)
10:25	142004 Open - Western Pleasure - Green (5)
11:05	238001 Amt Trail - Rookie (5)
11:25	238002 Amt Trail - Novice (11)
12:05	EWU: LK 3; Trail (10)
12:45	238000 Amt Trail (3)
13:30	434002 Youth Reining - Novice (5) AQHA Youth All-Around
14:00	EWU: LK 3, Reining (7)
14:45	242000 Amt Western Pleasure (1)
15:00	142000 Open - Western Pleasure (4)
15:30	143000 Open - Ranch Horse Pleasure (2) AQHA Open All-Around
15:50	EWU: LK 3, Western Horsemanship (8)
16:15	240001 Amt Western Horsemanship - Rookie (2)
16:25	240002 Amt Western Horsemanship - Novice (6)
16:45	240000 Amt Western Horsemanship (1) AQHA Amateur All-Around

ACHTUNG: Die AQHA-Klassen können, wenn der Zeitplan es zulässt, auch bis zu 15 Minuten vor der angegebenen Startzeiten beginnen. Bitte unbedingt auf die Ansagen während des Tages achten. Die Teilnehmer sind selbst für das rechtzeitige Erscheinen zu den Prüfungen verantwortlich!

# Showmanship at Halter

Rookie, Novice Amateur, Novice Youth,

EWU LK 4/5 A/B

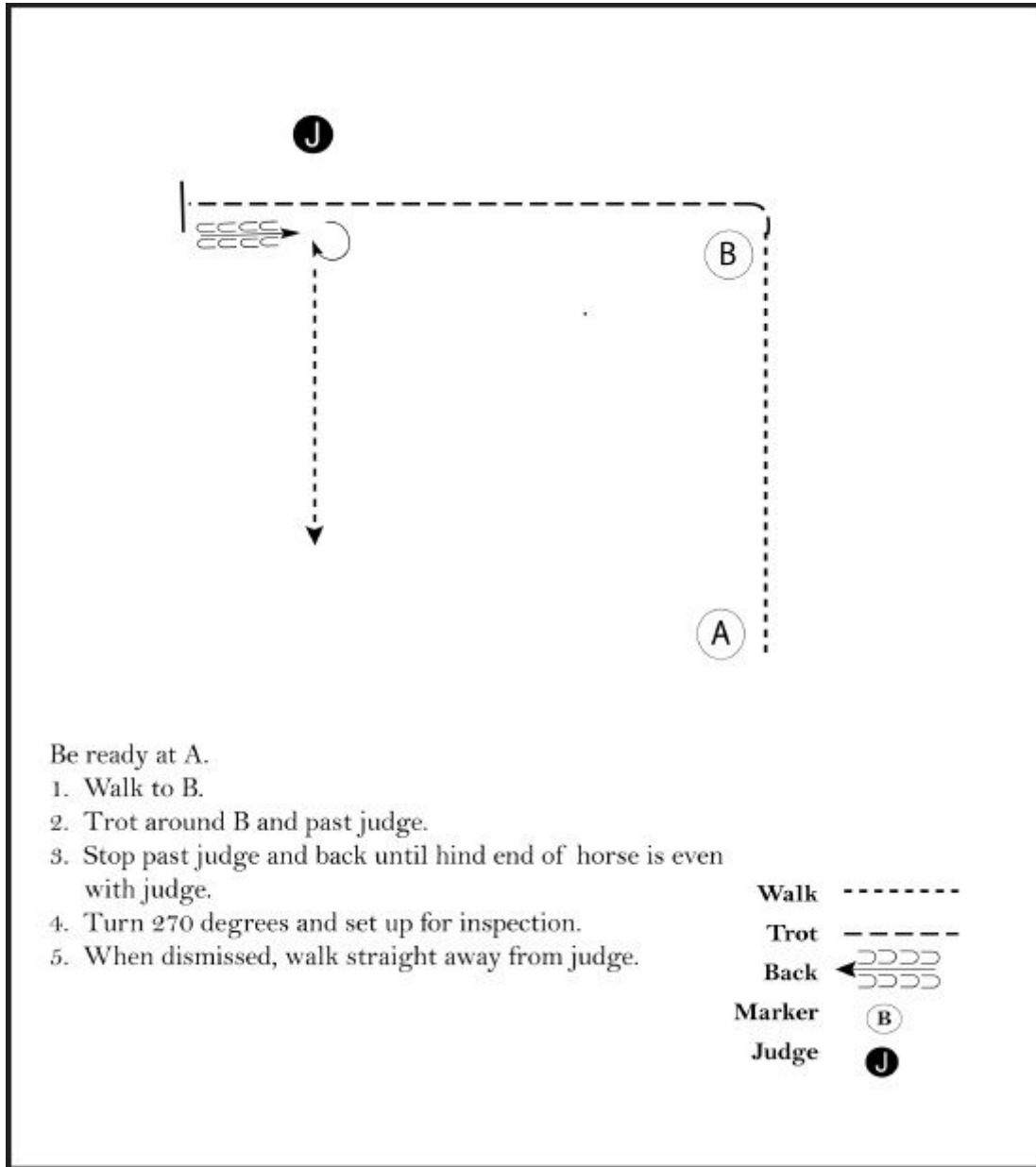

# Showmanship at Halter

Amateur

EWU LK 3 A/B

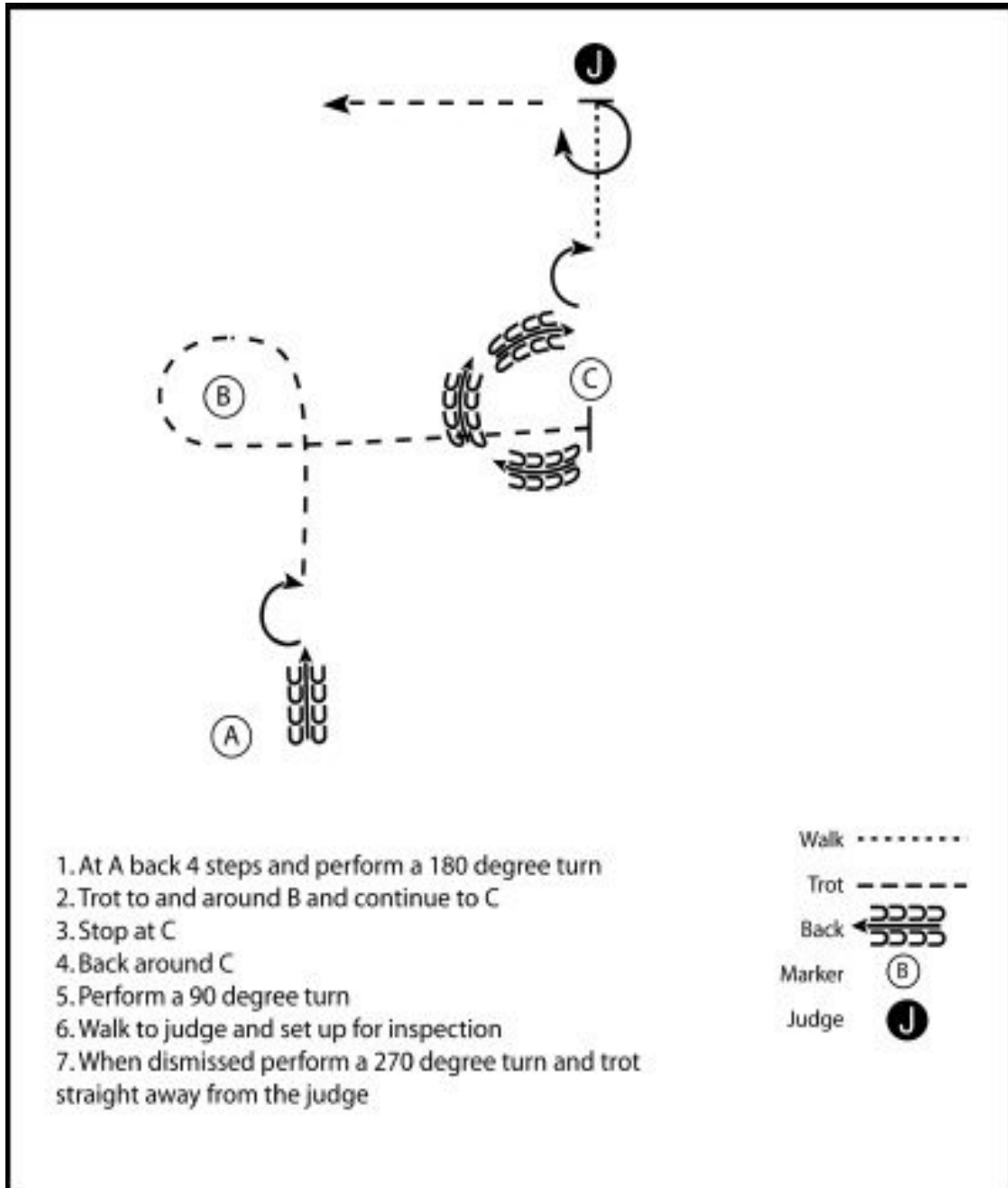

# Western Horsemanship

Novice Youth,

EWU LK 5 A/B, 4 A/B

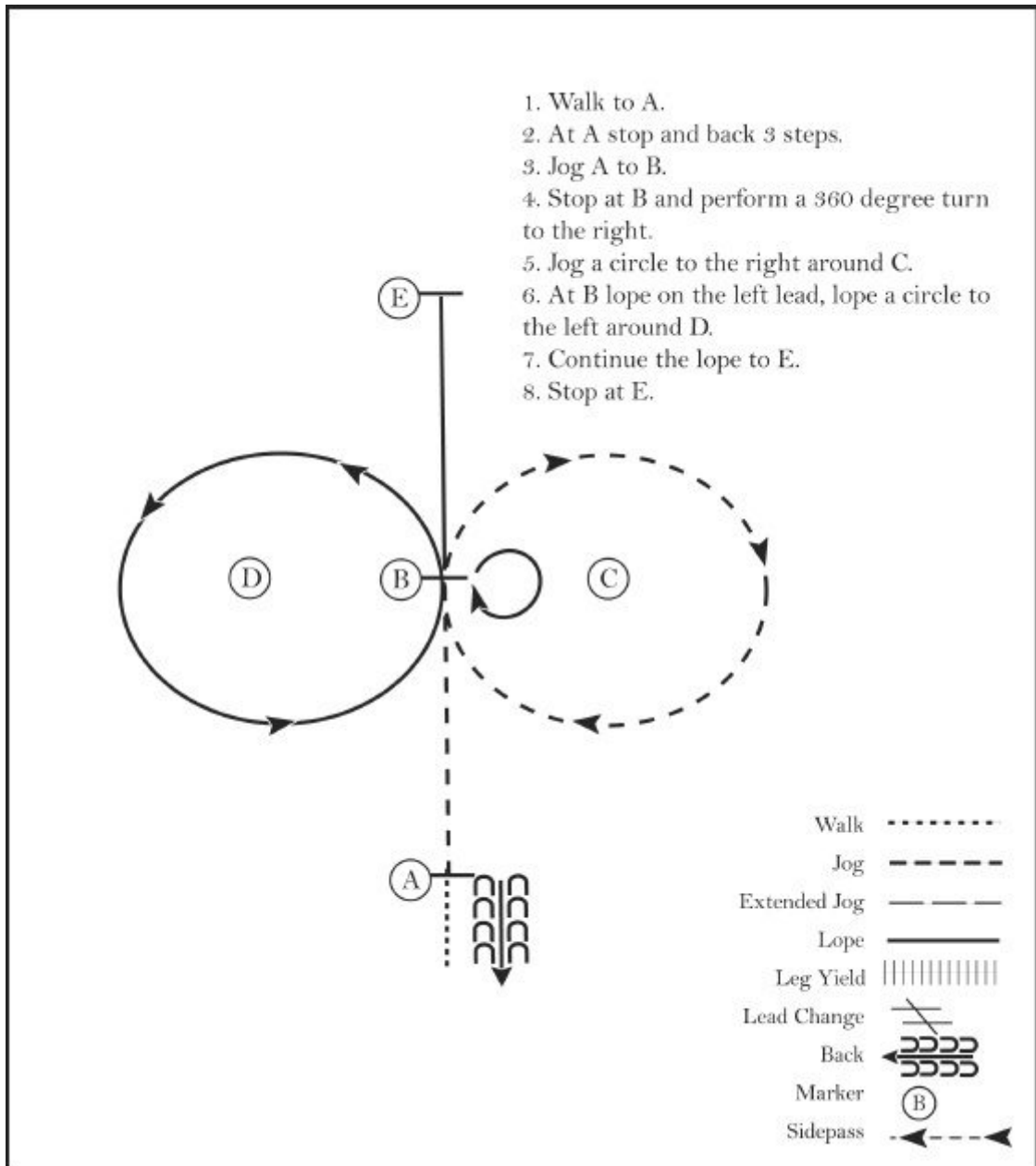

# Western Horsemanship

Amateur, Novice Amateur, Rookie

EWU LK 3

1. Walk A to B  
 2. At B jog to C  
 3. At C lope on the left lead in a half circle to E  
 4. Stop at E and perform a 180 degree turn to the right  
 5. Lope on the right lead in a half circle to C  
 6. At C jog to A  
 7. At A stop and back 4 steps

Walk	.....
Jog	-----
Extended Jog	-----
Lope	—————
Leg Yield	
Lead Change	↙ ↘
Back	←←←←
Marker	(B)
Sidepass	←←←←

## Pattern

### Reining:

Novice Amateur, Rookie	Pt. 6
Amateur, Open	Pt. 11
Open Green	Pt. 4
Novice Youth	Pt. 6
EWU LK 3, LK 4A	Pt. 6, Pt. 6a

### Western Riding:

Open green, Novice Youth	Green Pt. 4
Open	Pt. 4
EWU LK 3	Pt. 8

### Ranch Horse Pleasure

Open	Pt. 1
------	-------

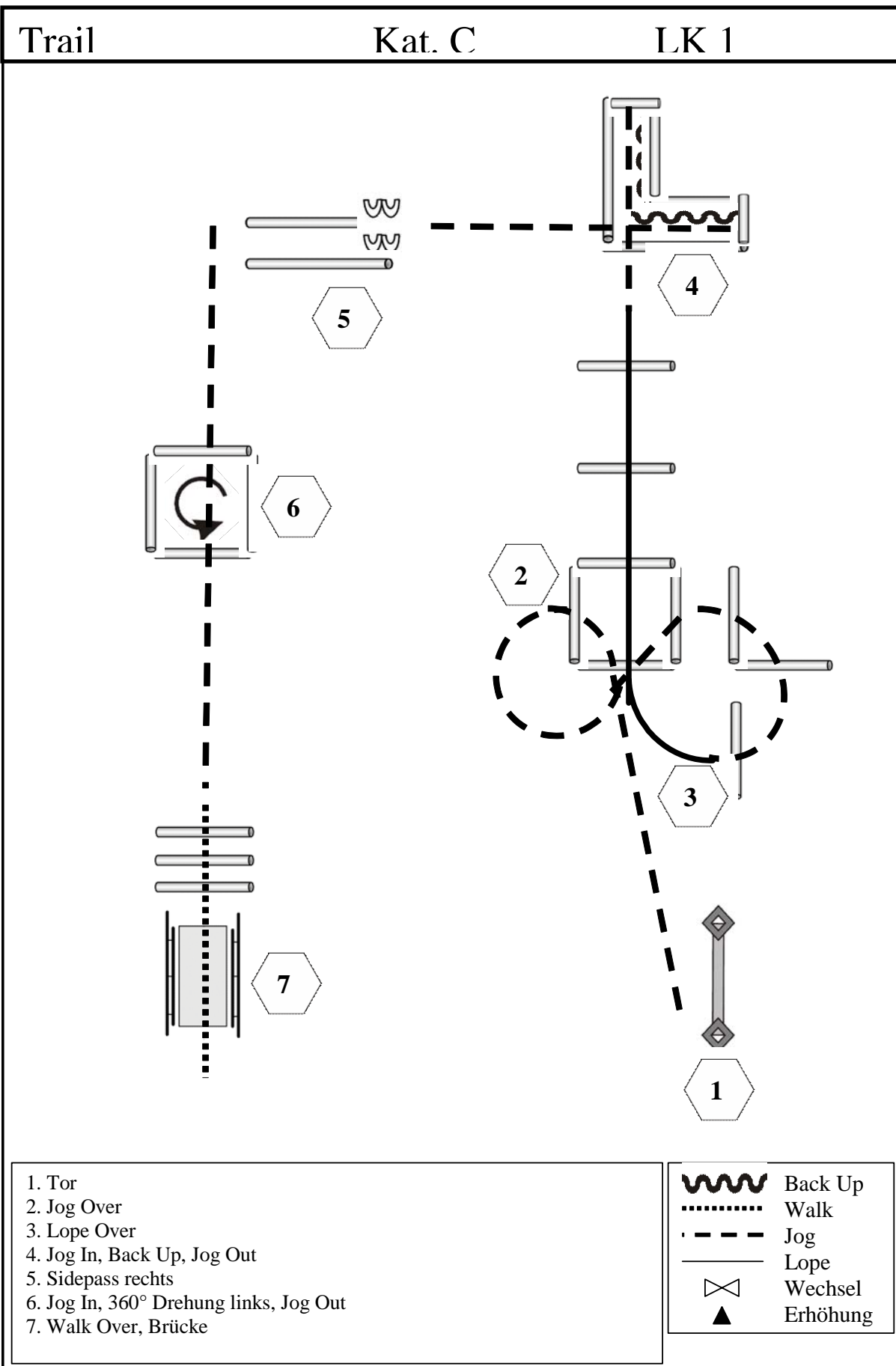



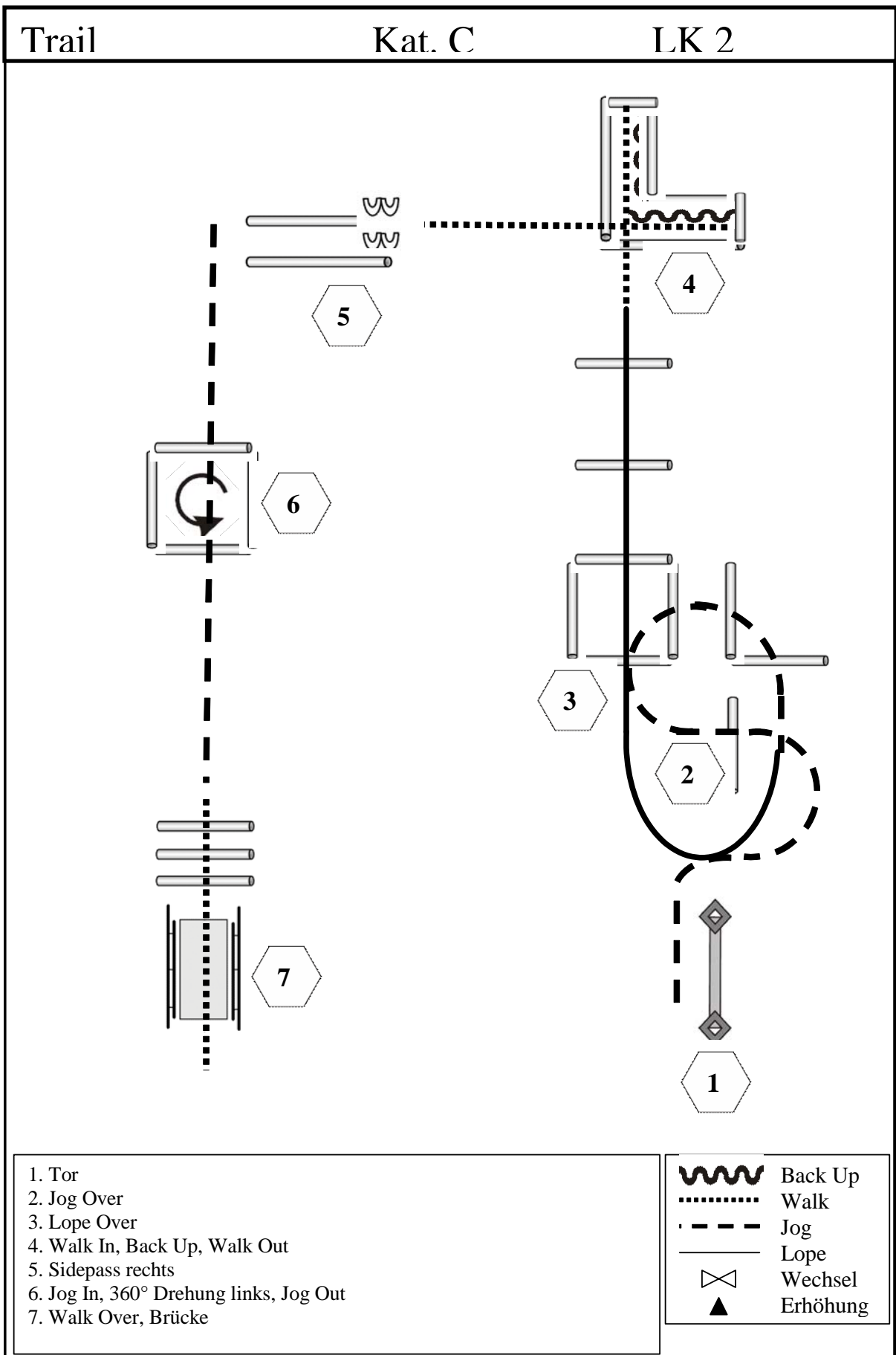

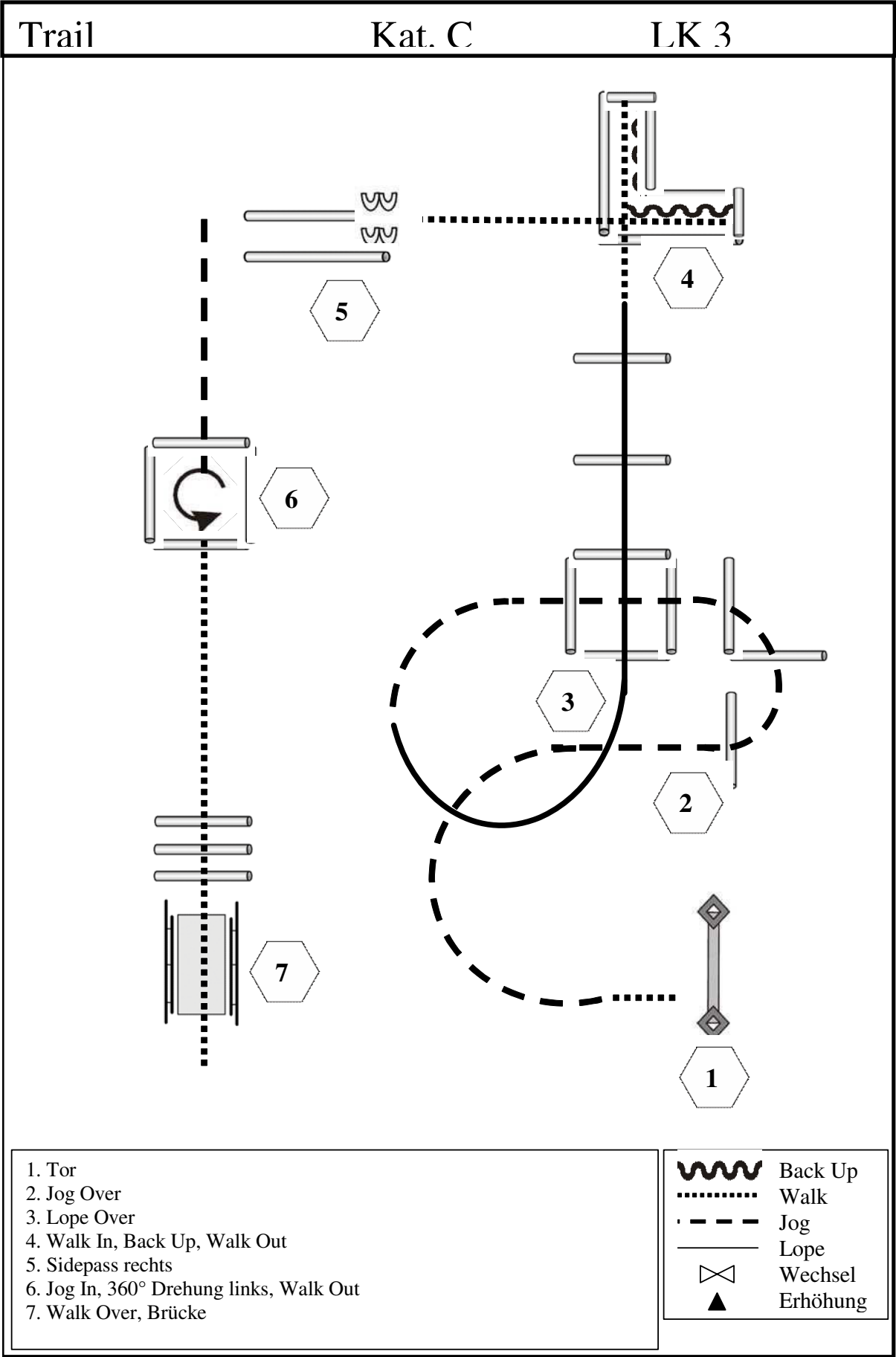

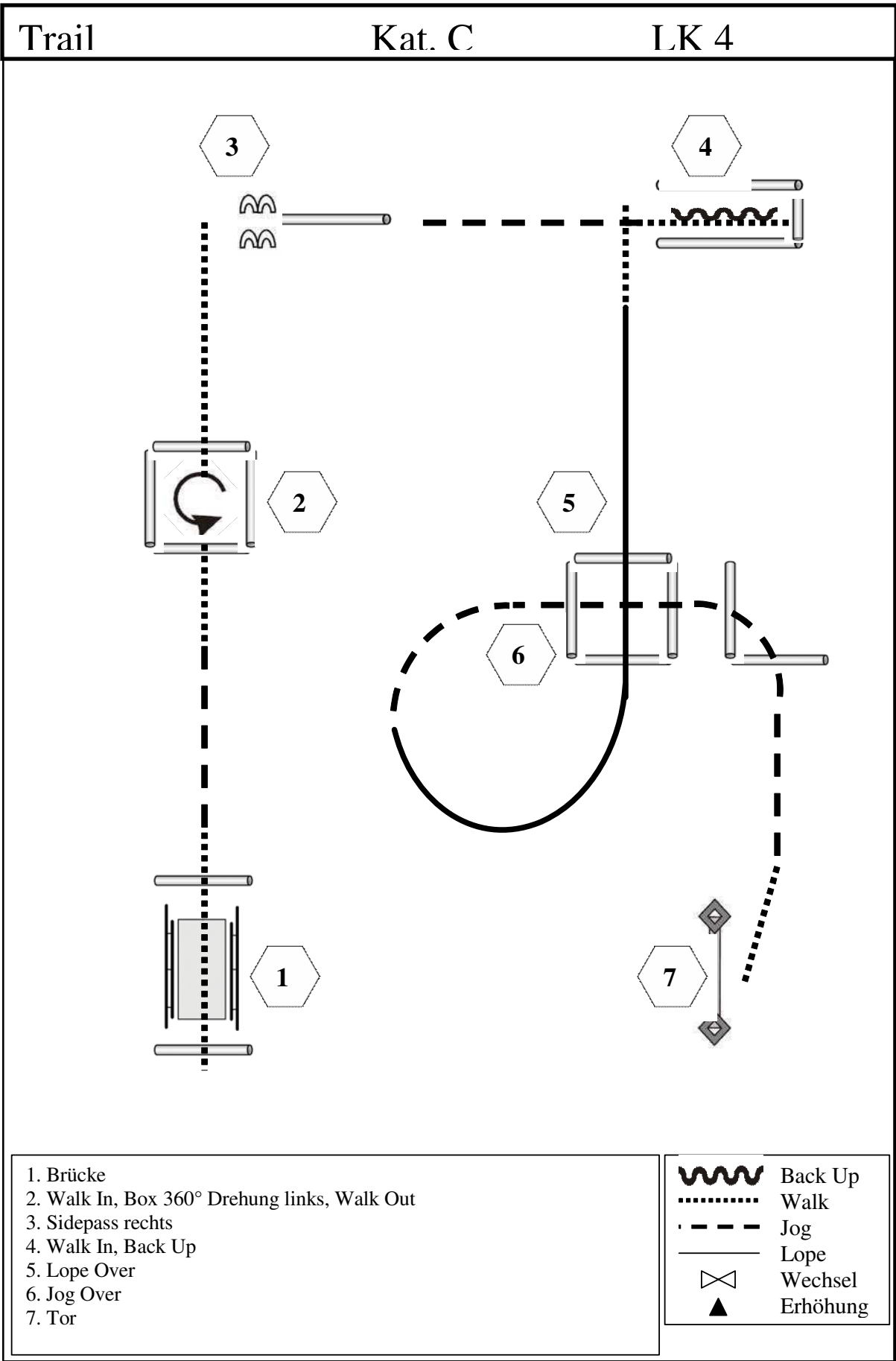

Trail

Kat. C

LK 5

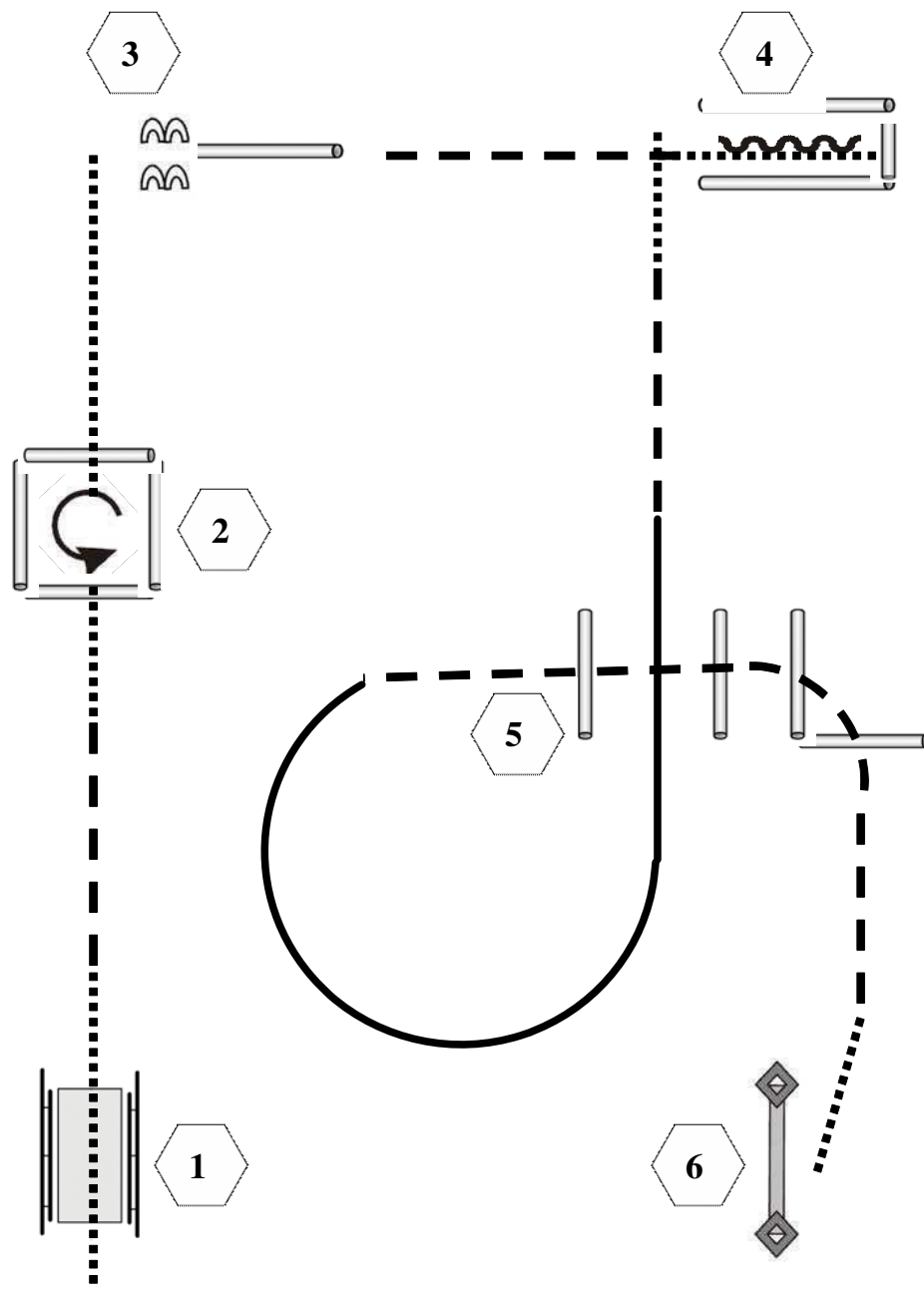

1. Brücke
2. Walk In, Box 360° Drehung links, Walk Out
3. Sidepass rechts
4. Walk In, Back Up
5. Jog Over
6. Tor

- |  |          |
|--|----------|
|  | Back Up  |
|  | Walk     |
|  | Jog      |
|  | Lope     |
|  | Wechsel  |
|  | Erhöhung |

§ 7830

Reining-Pattern 6 (Pattern 6 A: 2 Spins und einfache Wechsel)

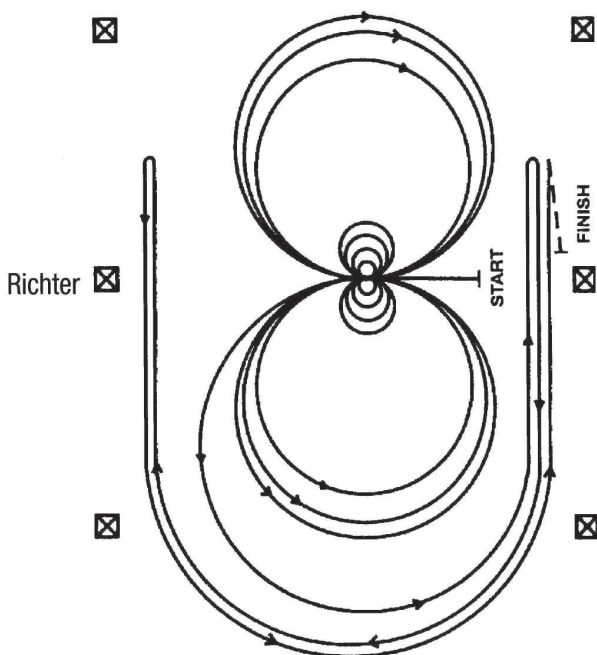

Im Schritt oder Trab zur Mitte der Bahn. Beginn der Aufgabe aus dem Schritt oder aus dem Halten.

Beginnend in der Mitte der Bahn mit Blickrichtung auf die linke Bande.

- 1) Volle 4 Spins nach rechts
- 2) Volle 4 Spins nach links – verharren
- 3) Beginnend im Linksgalopp, 3 vollständige Zirkel nach links, die ersten beiden Zirkel groß und schnell, der 3. Zirkel klein und langsam. Galoppwechsel im Mittelpunkt der Bahn
- 4) 3 vollständige Zirkel nach rechts (im Rechtsgalopp), die ersten beiden Zirkel groß und schnell, der 3. Zirkel klein und langsam. Galoppwechsel im Mittelpunkt der Bahn
- 5) Weiter mit einem großen, schnellen Zirkel nach links, der nicht geschlossen wird. Galopp entlang der rechten Seite der Bahn bis hinter den Mittelmarker – Rollback nach rechts – mind. 6 m von der Bande entfernt – kein Verharren
- 6) Zurück auf dem vorherigen Zirkel – nun auf der rechten Hand, der Zirkel wird nicht geschlossen. Galopp entlang der linken Seite der Bahn bis hinter den Mittelmarker – Rollback nach links – mind. 6 m von der Bande entfernt – kein Verharren
- 7) Zurück auf dem vorherigen Zirkel – nun wieder auf der linken Hand, der Zirkel wird nicht geschlossen. Galopp entlang der rechten Seite der Bahn bis hinter den Mittelmarker – Sliding stop – mind. 6 m von der Bande entfernt. Rückwärtsrichten von mind. 3 m. Verharren, um das Ende der Prüfung anzuzeigen.

Der Reiter muss Zaumzeug und Gebiss (Bridle) vor dem Richter abnehmen.

§ 7609

Western Riding-Pattern 8

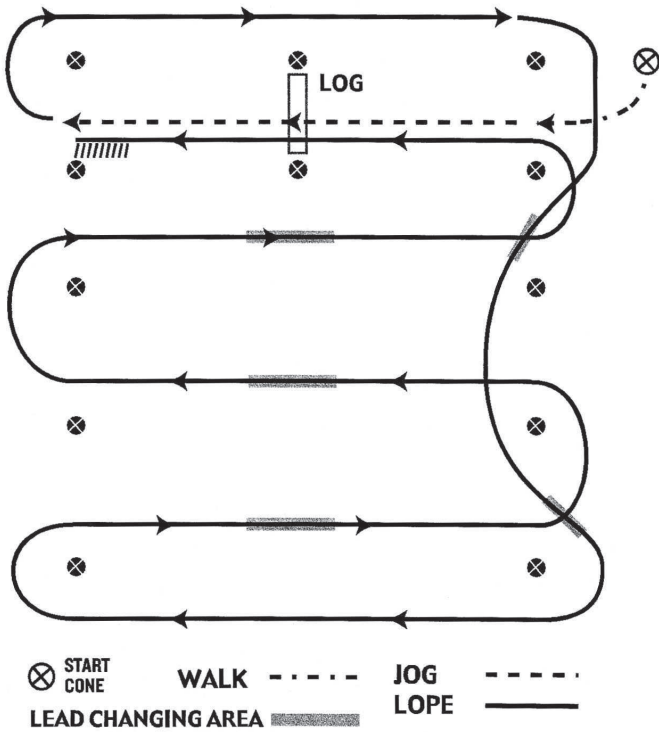

- 1) Schritt, zwischen den ersten beiden Markern Übergang zum Trab, Trab über die Stange
- 2) Zwischen den Markern Übergang zum Rechtsgalopp
- 3) 1. Wechsel auf der Linie
- 4) 2. Wechsel auf der Linie
- 5) 1. Wechsel auf der Mittellinie
- 6) 2. Wechsel auf der Mittellinie
- 7) 3. Wechsel auf der Mittellinie
- 8) Galopp über die Stange
- 9) Anhalten zwischen den Pylonen und mind. 3 m Rückwärtsrichten. Verharren, um das Ende der Aufgabe anzuzeigen.

### REINING PATTERN NUMBER 6

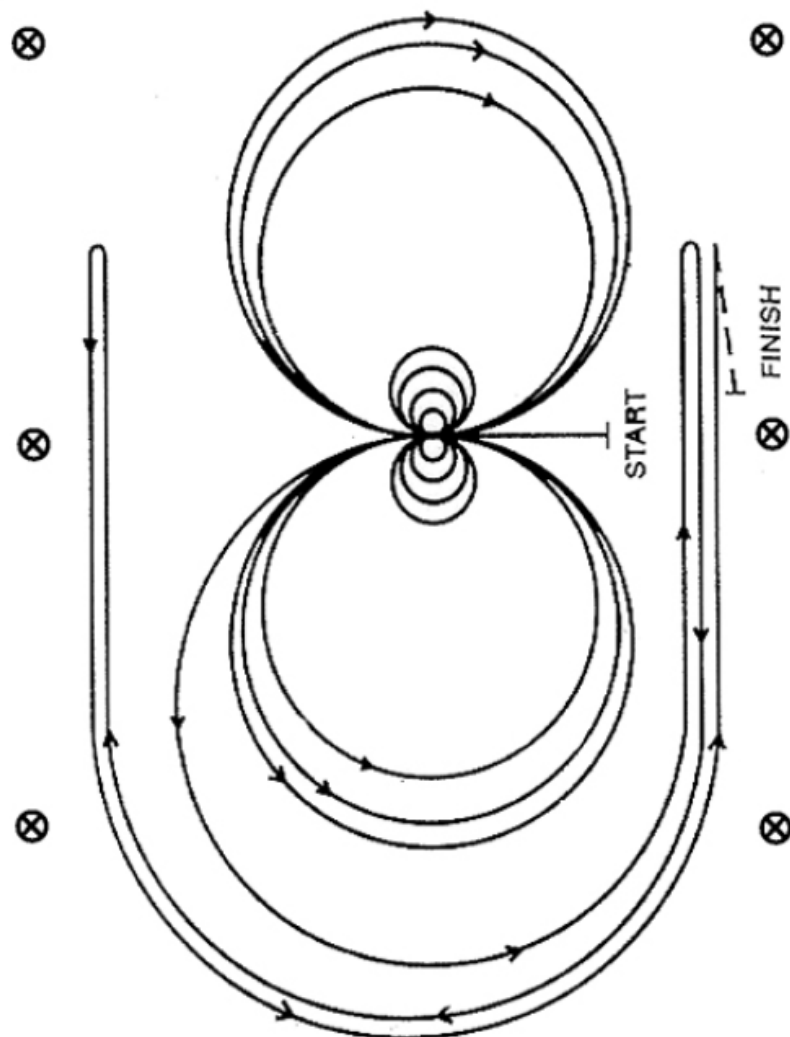

Horse must walk or stop prior to starting pattern.

Beginning at the center of the arena facing the left wall or fence.

1. Complete four spins to the right.
2. Complete four spins to the left. Hesitate.
3. Beginning on the left lead, complete three circles to the left: the first two circles large and fast; the third circle small and slow. Change leads at the center of the arena.
4. Complete three circles to the right: the first two circles large and fast; the third circle small and slow. Change leads at the center of the arena.
5. Begin a large fast circle to the left but do not close this circle. Run up the right side of the arena past the center marker and do a right roll-back at least 20 feet (6 meters) from the wall or fence - no hesitation.
6. Continue back around previous circle but do not close this circle. Run up the left side of the arena past the center marker and do a left roll-back at least 20 feet (6 meters) from the wall or fence - no hesitation.
7. Continue back around previous circle but do not close this circle. Run up the right side of the arena past the center marker and do a sliding stop at least 20 feet (6 meters) from the wall or fence. Back up at least 10 feet (3 meters). Hesitate to demonstrate the completion of the pattern.

Rider may drop bridle to the designated judge.

**REINING PATTERN NUMBER 11**

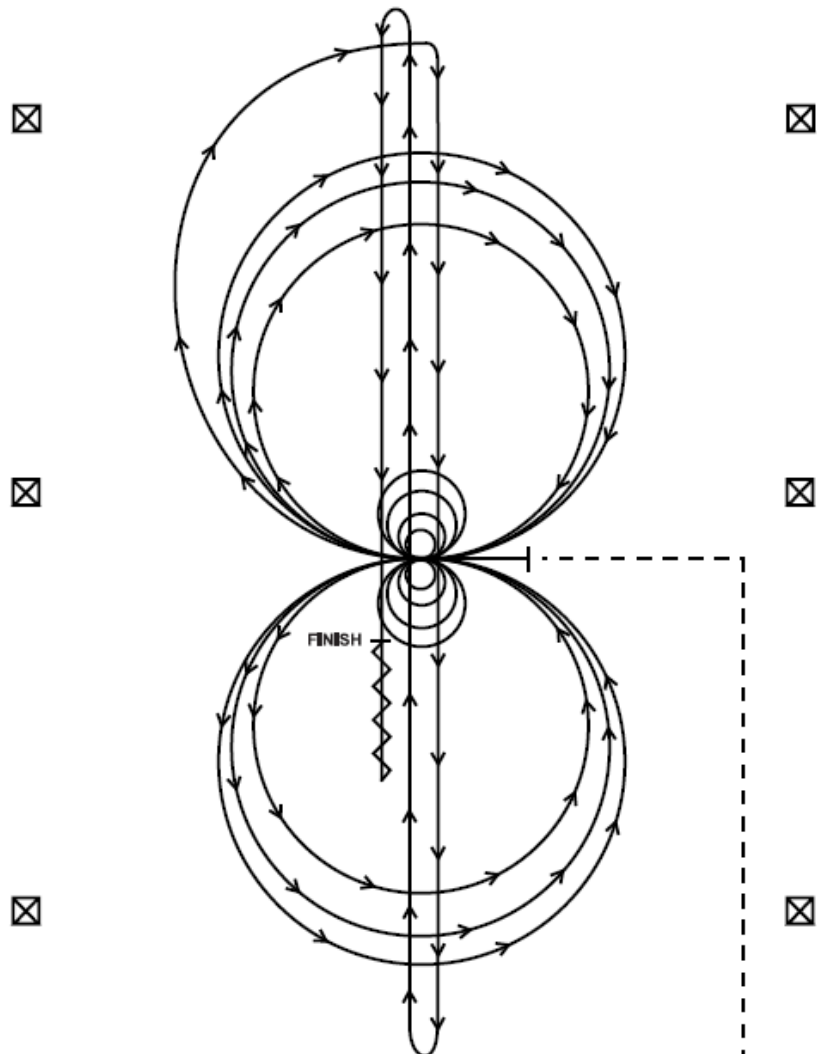

Horses must jog the majority of the way to the center. Failure to jog the majority of the way to the center will result in a 0 for failure to complete the pattern as written. Horses must walk or stop prior to starting pattern. Beginning at the center of the arena facing the left wall or fence.

1. Complete four spins to the left. Hesitate.
2. Complete four spins to the right. Hesitate.
3. Beginning on the right lead, complete three circles to the right; the first circle small and slow; the next two circles large and fast. Change leads at the center of the arena.
4. Complete three circles to the left; the first circle small and slow; the next two circles large and fast. Change leads at the center of the arena.
5. Begin a large circle to the right, but do not close this circle. Run down the center of the arena past the end marker and do a right rollback - no hesitation.
6. Run up the middle to the opposite end of the arena past the end marker and do a left rollback - no hesitation.
7. Run past the center marker and do a sliding stop. Back up to the center of the arena or at least ten feet (three meters). Hesitate to demonstrate completion of the pattern.



**REINING PATTERN NUMBER 4**

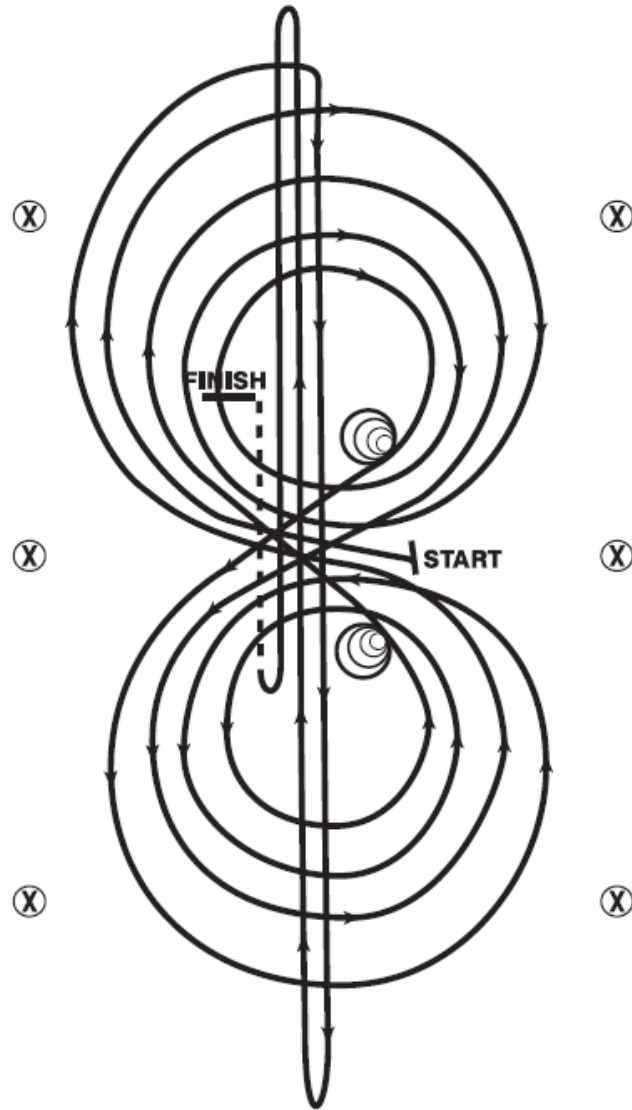

Horse must walk or stop prior to starting pattern.

Beginning at the center of the arena facing the left wall or fence.

1. Beginning on the right lead, complete three circles to the right: the first two circles large and fast; the third circle small and slow. Stop at the center of the arena.
2. Complete four spins to the right. Hesitate.
3. Beginning on the left lead, complete three circles to the left: the first two circles large and fast; the third circle small and slow. Stop at the center of the arena.
4. Complete four spins to the left. Hesitate.
5. Beginning on the right lead, run a large fast circle to the right, change leads at the center of the arena, run a large fast circle to the left, and change leads at the center of the arena.
6. Continue around previous circle to the right. At the top of the circle, run down the middle to the far end of the arena past the end marker and do a right rollback - no hesitation.
7. Run up the middle to the opposite end of the arena past the end marker and do a left rollback - no hesitation.
8. Run past the center marker and do a sliding stop. Back up to the center of the arena or at least 10 feet (3 meters). Hesitate to demonstrate completion of the pattern.

Rider may drop bridle to the designated judge.

### GREEN WESTERN RIDING PATTERN IV

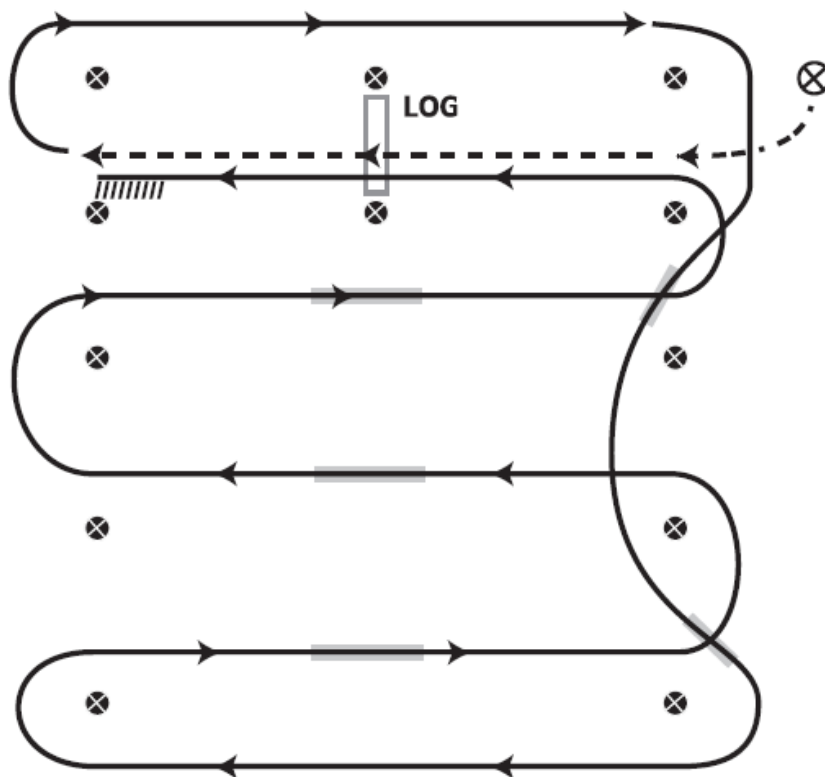

⊗ START CONE      WALK    - - - - -      JOG    - · - · - ·  
LEAD CHANGING AREA    █      LOPE    —————

1. Walk, transition to jog, jog over log
2. Transition to right lead & lope around end
3. First line change
4. Second line change, lope around end of arena
5. First crossing change
6. Second crossing change
10. Third crossing change
11. Lope over log
12. Lope, stop & back

**WESTERN RIDING PATTERN IV**

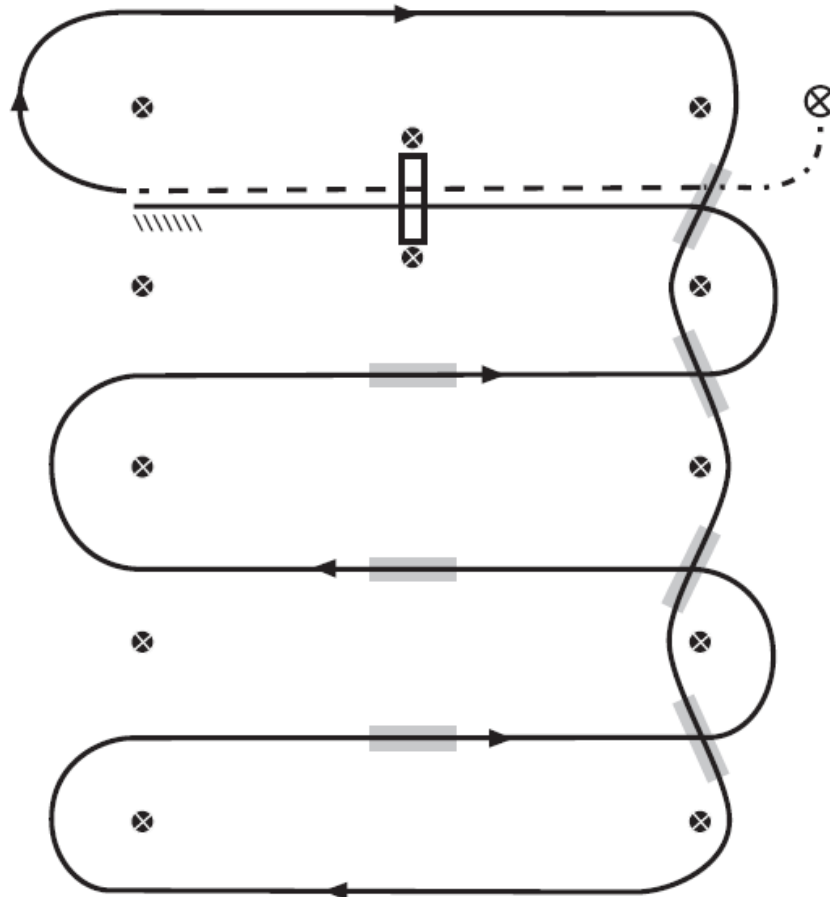

⊗ START CONE    WALK    · · · · ·    JOG    - - - - -  
LEAD CHANGING AREA    [shaded gray]    LOPE    —————

1. Walk, transition to jog, jog over log
2. Transition to the lope, on the right lead
3. First line change
4. Second line change
5. Third line change
6. Fourth line change
7. First crossing change
8. Second crossing change
9. Third crossing change
10. Lope over log
11. Lope, Stop & back

### RANCH PLEASURE – PATTERN I

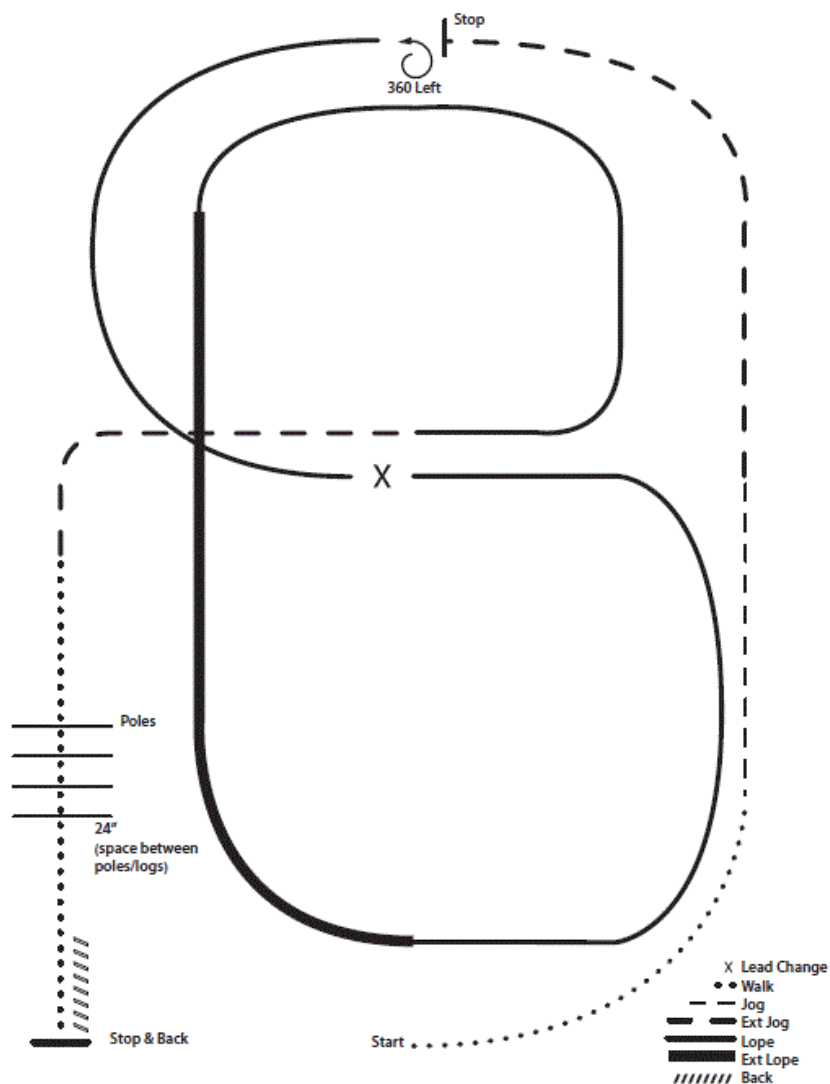

1. Walk
2. Jog
3. Extend the jog ,at the top of the arena ,stop
4. 360 turn to the left
5. Left lead ½ circle, lope to the center
6. Change leads (simple or flying)
7. Right lead ½ circle
8. Extended lope up the long side of the arena (right lead)
9. Collect back to a lope around the top of the arena and back to center
10. Break down to a jog
11. Walk over poles
12. Stop and back